

SmartLogger2000

User Manual

Issue **07**
Date **2019-12-20**

Copyright © Huawei Technologies Co., Ltd. 2019. All rights reserved.

No part of this document may be reproduced or transmitted in any form or by any means without prior written consent of Huawei Technologies Co., Ltd.

Trademarks and Permissions



HUAWEI and other Huawei trademarks are trademarks of Huawei Technologies Co., Ltd.

All other trademarks and trade names mentioned in this document are the property of their respective holders.

Notice

The purchased products, services and features are stipulated by the contract made between Huawei and the customer. All or part of the products, services and features described in this document may not be within the purchase scope or the usage scope. Unless otherwise specified in the contract, all statements, information, and recommendations in this document are provided "AS IS" without warranties, guarantees or representations of any kind, either express or implied.

The information in this document is subject to change without notice. Every effort has been made in the preparation of this document to ensure accuracy of the contents, but all statements, information, and recommendations in this document do not constitute a warranty of any kind, express or implied.

Huawei Technologies Co., Ltd.

Address: Huawei Industrial Base
Bantian, Longgang
Shenzhen 518129
People's Republic of China

Website: <https://e.huawei.com>

About This Document

Overview

This document introduces the SmartLogger2000 (**SmartLogger** for short) in terms of installation, electrical connections, system operation, maintenance, and troubleshooting. You should understand the SmartLogger features, functions, and safety precautions provided in this document before installing and operating the SmartLogger.

The figures provided in this document are for reference only. The actual product appearance prevails.





You can print the document. Store the paper copies properly for future use.

Intended Audience

This document is intended for photovoltaic (PV) plant operators and qualified electrical technical personnel.

Symbol Conventions

The symbols that may be found in this document are defined as follows.

Symbol	Description
	Indicates a hazard with a high level of risk which, if not avoided, will result in death or serious injury.
	Indicates a hazard with a medium level of risk which, if not avoided, could result in death or serious injury.
	Indicates a hazard with a low level of risk which, if not avoided, could result in minor or moderate injury.
	Indicates a potentially hazardous situation which, if not avoided, could result in equipment damage, data loss, performance deterioration, or unanticipated results. NOTICE is used to address practices not related

Symbol	Description
	to personal injury.
 NOTE	Supplements the important information in the main text. NOTE is used to address information not related to personal injury, equipment damage, and environment deterioration.

Change History

Changes between document issues are cumulative. The latest document issue contains all the changes made in earlier issues.

Issue 07 (2019-12-20)

Updated [7.4 WebUI Menu](#).

Updated [7.11.2.5 Setting Modbus TCP Parameters](#).

Updated [7.11.2.7 Setting IEC104 Parameters](#).

Updated [7.11.3.1 Setting FTP Parameters](#).

Issue 06 (2019-07-30)

Updated [7.4 WebUI Menu](#).

Updated [7.7 Performing Deployment Wizard](#).

Updated [7.9.2.2 Setting Running Parameters \(Advanced User\)](#).

Updated [7.9.4 EMI](#).

Updated [7.11.2.3 Setting Power Meter Parameters](#).

Updated [7.11.5 Alarm Output](#).

Added [7.11.6 Setting Smart Tracking Algorithm Parameters](#).

Updated [7.12.7 Managing the License](#).

Updated [8.1 Active Power Control](#).

Updated [8.2 Reactive Power Adjustment](#).

Updated [8.5 Setting Export Limitation Parameters](#).

Added [8.6 Setting Smart Reactive Power Compensation Parameters](#).

Issue 05 (2018-10-20)

Updated [7.4 WebUI Menu](#).

Added [7.7 Performing Deployment Wizard](#).

- Updated [7.9.2.2 Setting Running Parameters \(Advanced User\)](#).
- Updated [7.9.2.3 Setting Running Parameters \(Special User\)](#).
- Added [7.9.7 PID-PVBOX](#).
- Added [7.9.8 PID-SSC](#).
- Added [7.9.9 Smart Transformer Station \(STS\)](#).
- Updated [7.11.2.4 Setting Management System Parameters](#).
- Updated [7.11.2.7 Setting IEC104 Parameters](#).
- Updated [7.11.3.1 Setting FTP Parameters](#).
- Updated [7.11.3.2 Setting Email Parameters](#).
- Updated [7.12.1 Upgrading Firmware](#).
- Updated [7.12.8.5 Data Recollection](#).
- Updated [8.1.2 DI Active Scheduling](#).
- Added [8.2.11 PF-U Characteristic Curve](#).
- Added [8.2.12 Dry Contact Remote Control \(Q/S\)](#).

Issue 04 (2018-04-10)

- Updated [7.1 Introduction to WebUI](#).
- Updated [7.11.2.4 Setting Management System Parameters](#).
- Updated [7.11.3.1 Setting FTP Parameters](#).
- Updated [7.12.2 Product Information](#).
- Updated [8.5 Setting Export Limitation Parameters](#).

Issue 03 (2018-03-15)

- Updated [7.1 Introduction to WebUI](#).
- Updated [7.9.2.2 Setting Running Parameters \(Advanced User\)](#).
- Updated [7.9.2.3 Setting Running Parameters \(Special User\)](#).
- Added [7.11.1.5 Setting the Name of the Built-in Bluetooth Module](#).
- Updated [7.11.2.2 Setting RS485 Parameters](#).
- Updated [7.11.2.3 Setting Power Meter Parameters](#).
- Added [8.5 Setting Export Limitation Parameters](#).
- Updated [7.12.8.4 Clearing Alarms](#).
- Added [8.2.10 Power Factor Closed-loop Control](#).

Issue 02 (2017-11-10)

- Updated [7.1 Introduction to WebUI](#).
- Updated [7.4 WebUI Menu](#).

Updated [7.9.2.2 Setting Running Parameters \(Advanced User\)](#).

Updated [7.9.2.3 Setting Running Parameters \(Special User\)](#).

Added [7.11.5 Alarm Output](#).

Issue 01 (2017-07-20)

This issue is the first official release.

Contents

About This Document	ii
1 Safety Precautions	1
2 Product Overview	3
2.1 Overview	3
2.2 Appearance	6
2.3 Nameplate Description	12
2.4 Typical Networking Scenarios	15
2.5 System Wiring Diagram.....	17
3 Device Installation	31
3.1 Precautions.....	31
3.2 Checking Before Installation	31
3.3 Tools	31
3.4 Determining the Installation Position	34
3.5 Installing a SmartLogger	36
3.5.1 Installing a SmartLogger on a Wall	36
3.5.2 Installing a SmartLogger Along a Guide Rail.....	39
4 Electrical Connection	43
4.1 Precautions.....	43
4.2 Preparing an OT Terminal.....	43
4.3 Connecting Cables to the Terminal Block on the COM Port.....	44
4.4 Connecting a PE Cable to the SmartLogger	45
4.5 Connecting the SUN2000	46
4.5.1 Connection Description	46
4.5.2 Connecting the SUN2000 over RS485	46
4.5.3 Connecting the SUN2000 Through AC Power Cables	52
4.5.4 Connecting Multiple SUN2000s.....	54
4.6 Connecting an EMI.....	56
4.6.1 Connection Description	56
4.6.2 Connecting the SmartLogger to an EMI That Supports Standard Modbus-RTU.....	56
4.6.3 Connecting the SmartLogger to a Split EMI	58
4.7 Connecting a Power Meter	61

4.8 Connecting a Box-type Transformer	63
4.9 Connecting a PID Module	64
4.10 Connecting a Ripple Control Receiver	66
4.11 Connecting an Ethernet Network Cable	68
4.12 Connecting Fiber Jumpers	69
5 System Operation.....	72
5.1 Checking Before Power-On	72
5.2 System Power-On	73
6 Man-Machine Interaction.....	75
6.1 USB Flash Drive Operation	75
6.1.1 Exporting Data	75
6.1.2 Exporting All Files	76
6.1.3 Importing All Files	78
6.1.4 Upgrading the Application	79
6.1.5 Upgrading the BSP	81
6.2 NMS Operation	82
6.3 App Operation	82
7 WebUI.....	83
7.1 Introduction to WebUI	83
7.2 Preparations for Login	84
7.3 Logging In to the WebUI	88
7.4 WebUI Menu	89
7.5 Icon Description	95
7.6 WebUI Layout	96
7.7 Performing Deployment Wizard	97
7.8 Overview	98
7.8.1 Plant Running Information	98
7.8.2 Active Alarm	99
7.8.3 Plant Yield	99
7.8.4 Performance Data	100
7.8.5 Device Running Information	101
7.9 Device Monitoring	102
7.9.1 SmartLogger	102
7.9.1.1 Querying Master SmartLogger-Related Information	102
7.9.1.2 Querying Slave SmartLogger-Related Information	103
7.9.2 SUN2000	103
7.9.2.1 Querying Related Information	103
7.9.2.2 Setting Running Parameters (Advanced User)	104
7.9.2.3 Setting Running Parameters (Special User)	111
7.9.2.4 Setting a Tracking System	120
7.9.2.5 Setting Characteristic Curves	121

7.9.3 SmartMBUS	122
7.9.3.1 Querying Related Information	122
7.9.3.2 Setting the STA List	123
7.9.3.3 Networking Settings	124
7.9.4 EMI.....	125
7.9.4.1 Querying Related Information	125
7.9.4.2 Setting Modbus-RTU EMI Parameters	126
7.9.4.3 Setting AI EMI Parameters	128
7.9.4.4 PT Temperature Correction.....	129
7.9.5 Power Meter.....	130
7.9.5.1 Querying Related Information	130
7.9.5.2 Setting Running Parameters.....	131
7.9.6 PID.....	132
7.9.6.1 Querying Related Information	132
7.9.6.2 Setting Running Parameters.....	133
7.9.7 PID-PVBOX.....	138
7.9.7.1 Querying Related Information	138
7.9.7.2 Setting Running Parameters.....	139
7.9.8 PID-SSC	139
7.9.8.1 Querying Related Information	139
7.9.8.2 Setting Running Parameters.....	140
7.9.9 Smart Transformer Station (STS)	141
7.9.9.1 Querying Related Information	141
7.9.9.2 Setting STS Parameters	141
7.9.10 Custom Device, IEC103 Device, or IEC104 Device	142
7.9.10.1 Querying Related Information	142
7.9.10.2 Setting Telecontrol Parameters	143
7.9.10.3 Setting Teleadjust Parameters	144
7.10 Querying Historical Data	145
7.10.1 Querying Historical Alarms	145
7.10.2 Querying Operation Logs	145
7.10.3 Exporting Data.....	146
7.11 Settings	148
7.11.1 User Parameters	148
7.11.1.1 Setting the Date and Time	148
7.11.1.2 Setting Plant Information	148
7.11.1.3 Setting Gain Parameters.....	149
7.11.1.4 Setting the Save Period	150
7.11.1.5 Setting the Name of the Built-in Bluetooth Module	151
7.11.2 Communications Parameters.....	152
7.11.2.1 Setting Wired Network Parameters	152
7.11.2.2 Setting RS485 Parameters.....	153

7.11.2.3 Setting Power Meter Parameters	154
7.11.2.4 Setting Management System Parameters	155
7.11.2.5 Setting Modbus TCP Parameters	156
7.11.2.6 Setting IEC103 Parameters	157
7.11.2.7 Setting IEC104 Parameters	158
7.11.3 Extended Parameters	158
7.11.3.1 Setting FTP Parameters	158
7.11.3.2 Setting Email Parameters	160
7.11.4 Port Settings	162
7.11.4.1 Setting DO Parameters	162
7.11.4.2 Setting USB Parameters	164
7.11.5 Alarm Output	165
7.11.6 Setting Smart Tracking Algorithm Parameters	166
7.12 Maintenance	169
7.12.1 Upgrading Firmware	169
7.12.2 Product Information	169
7.12.3 Setting Security Parameters	170
7.12.4 System Maintenance	171
7.12.5 Device Log	171
7.12.6 Site Test	171
7.12.7 Managing the License	172
7.12.8 Device Management	173
7.12.8.1 Connecting Devices	173
7.12.8.2 Device List	175
7.12.8.3 Exporting Parameters	175
7.12.8.4 Clearing Alarms	176
7.12.8.5 Data Recollection	177
7.12.8.6 Correcting the Total Energy Yield	178
8 Power Grid Scheduling	179
8.1 Active Power Control	179
8.1.1 No Limit	179
8.1.2 DI Active Scheduling	180
8.1.3 Percentage Fixed-value Limitation (Open Loop)	180
8.1.4 Remote Communication Scheduling	181
8.1.5 Grid Connection with Limited Power (kW)	181
8.1.6 Remote Output Control	183
8.2 Reactive Power Adjustment	184
8.2.1 No Output	184
8.2.2 DI Reactive Scheduling	184
8.2.3 Reactive Power Fix Control	185
8.2.4 Power Factor Fix Control	185

8.2.5 Q-U Characteristic Curve	186
8.2.6 $\cos\phi$ -P/Pn Characteristic Curve	186
8.2.7 Q-U Hysteresis Curve (CEI0-16).....	187
8.2.8 Remote Communication Scheduling	188
8.2.9 Power Factor Closed-loop Control (Old Policy).....	188
8.2.10 Power Factor Closed-loop Control	189
8.2.11 PF-U Characteristic Curve	190
8.2.12 Dry Contact Remote Control (Q/S)	190
8.3 Remote Shutdown.....	191
8.4 Setting DI Parameters	194
8.5 Setting Export Limitation Parameters.....	195
8.6 Setting Smart Reactive Power Compensation Parameters	197
9 Device Maintenance	199
9.1 Routine Maintenance	199
9.2 Troubleshooting	199
9.3 Alarm List	202
10 FAQ.....	205
10.1 How Do I Set Anti-crosstalk Parameters?.....	205
10.2 Which Models of Power Meters and EMIs Are Supported by the SmartLogger?	206
11 SmartLogger Disposal.....	210
12 Technical Specifications	211
13 Product User Lists	214
14 Domain Name List of Management Systems	216
15 Acronyms and Abbreviations.....	217
A Installing and Wiring the RS485 Signal SPD.....	219
A.1 Installing the RS485 signal SPD.....	219
A.2 Connecting the RS485 Signal SPD.....	221

1 Safety Precautions

Read the safety precautions carefully. Otherwise, human injury and equipment damage may occur.

Personnel Requirements

- Only qualified and trained electrical technicians are allowed to install and operate the SmartLogger.
- Operators should understand the components and functioning of a grid-tied PV power system, and they should be familiar with relevant local standards.

CAUTION

Read this document thoroughly before operations. Huawei shall not be liable for any consequence caused by violation of the storage, transportation, installation, and operation regulations specified in this document.

Label Protection

- Do not tamper with any signs on the SmartLogger enclosure because these signs contain important information about safe operation.
- Do not remove or damage the nameplate at the rear of the SmartLogger enclosure because it contains important product information.

Installation

- Ensure that the SmartLogger is not connected to a power supply and is not powered on before starting installation.
- Install the SmartLogger in an environment with good ventilation to ensure efficient and long-term system performance.
- Ensure that the heat dissipation holes of the SmartLogger are not blocked.
- During installation, do not touch any component inside the enclosure except the wiring terminals at the bottom.
- Install the SmartLogger in a dedicated area.

Operation

NOTICE

Perform operations in strict accordance with safety precautions specified in this document and other relevant documents.

When operating Huawei equipment, you must follow the local laws and regulations.

Maintenance and Replacement

- A faulty SmartLogger requires overall maintenance. Contact the dealer if the SmartLogger is faulty.
- With sufficient knowledge of this document, maintain the SmartLogger by using proper tools and testing equipment.
- When maintaining the SmartLogger, wear electrostatic discharge (ESD) gloves and comply with ESD precautions.
- The device has multiple inputs. Switch off all inputs before maintenance.

2 Product Overview

2.1 Overview

Function

The SmartLogger is a highly integrated device dedicated for monitoring and managing the PV power system. It converges ports, converts protocols, collects and stores data, and centrally monitors and maintains devices in the PV power system.

Model Description

Model	Description
SmartLogger2000-10	10: with a built-in 500 V AC SmartMBUS (PLC CCO)
SmartLogger2000-10-B	10-B: with a built-in 500 V AC SmartMBUS (PLC CCO)
SmartLogger2000-11-B	11-B: without a built-in SmartMBUS (PLC CCO)
SmartLogger2000-10-C	10-C: with a built-in 800 V AC SmartMBUS (PLC CCO)
SmartLogger2000-11-C	11-C: without a built-in SmartMBUS (PLC CCO)

NOTE

- The SmartLogger with a built-in SmartMBUS (PLC CCO) can work with the SUN2000 that integrates a MBUS (PLC) station (STA) to implement MBUS networking over existing power cables.
- If the SmartLogger without a built-in SmartMBUS (PLC CCO) is required to network with the SUN2000 that integrates a MBUS (PLC) STA, connect a SmartMBUS (PLC CCO) to the SmartLogger.
- The built-in Bluetooth module of the SmartLogger2000-10 supports only Android apps. Built-in Bluetooth modules of other SmartLogger models support both Android and iOS apps.
- This document uses the SmartLogger2000-10-C as an example to describe the typical networking scenario, installation, and cable connection.

Features

The SmartLogger provides the following features:

- Wide application
 - Industrial-grade application, wide temperature range: -40°C to $+60^{\circ}\text{C}$
 - High altitude: applicable at an altitude of 4000 m
- Various communication modes
 - Bluetooth
Has a built-in Bluetooth module through which the SUN2000 APP (APP for short) connects to the SmartLogger for parameter configuration and device maintenance. The SmartLogger Bluetooth is named as **LOG+the last eight figures of the SN of the SmartLogger**. Users can change the name.
 - Optical fiber ring switch
Provides two 100M Ethernet optical ports that support RSTP and STP to implement fiber ring networking. If RSTP is used, fiber ring protection can be completed within 10 seconds. If STP is used, fiber ring protection can be completed within 60 seconds.

NOTE

The actual time depends on the fiber ring switch of the third party.

- MBUS
 - Has a built-in SmartMBUS (PLC CCO) through which southbound devices connect to the SmartLogger over AC power cables.
 - The maximum voltage for the built-in SmartMBUS (PLC CCO) of the SmartLogger2000-10/10-B is 500 V AC. The maximum voltage for the built-in SmartMBUS (PLC CCO) of the SmartLogger2000-10-C is 800 V AC.
- Ethernet electrical port
Provides two 10/100M Ethernet electrical ports that can be used as southbound ports to connect to southbound devices or used as northbound ports to connect to an NMS.

NOTE

- A southbound port connects to a downstream device for collecting data and setting parameters.
- Southbound devices include the inverter, environmental monitoring instrument (EMI), electricity meter, box-type transformer, and PID module.
- A northbound port connects to an upstream NMS for uploading data.
- RS485
 - Supports six RS485 routes and access of devices that use Modbus-RTU, standard IEC103, and DL/T645.
 - RS485 supports both Modbus-Slave and Modbus-Control. If RS485 is set to Modbus-Slave mode, the SmartLogger is in standby mode and can interconnect with third-party data collectors and communication management units. If RS485 is set to Modbus-Control mode, inverters that connect to the SmartLogger conduct rapid power grid scheduling by using both MBUS (PLC) and RS485 communication.
- Graphical data
 - In addition to displaying the electricity yield and real-time monitoring information in graphic and text format, the embedded WebUI can also display performance data of PV plants and devices in tables or curves.

- The APP displays the electricity yield and real-time monitoring information in graphic and text format.
- Centralized monitoring
 - The SmartLogger manages up to 200 devices in a centralized manner.
 - Each SmartLogger2000-10/10-B/11-B connects to a maximum of 80 inverters.
 - Each SmartLogger2000-10-C/11-C connects to a maximum of 150 inverters.
 - Allows you to monitor and manage the PV power system on the embedded WebUI, for example, viewing real-time information about PV plants, devices, and faults, setting device parameters, and maintaining devices in remote mode.
 - Allows you to monitor the devices in the PV power system on the APP in real time, such as viewing information about PV plants, devices, products, and faults, setting device parameters, and maintaining devices.
- Easy maintenance
 - Allows users to upgrade the firmware of the SmartLogger and export data by using a USB flash drive.
 - Allows you to upgrade the firmware of the SmartLogger, inverter, SmartMBUS, and PID module, and export logs and data over the embedded WebUI.
 - Allows you to manage the devices connecting to the SmartLogger, upgrade the firmware of these devices, exports data from these devices, and classify and query alarms over the app.
- Intelligent management
 - Automatically searches for and accesses Huawei inverters, SmartMBUSs, and PID modules. If you import a parameter configuration table, the SmartLogger can access third-party devices that support Modbus-RTU and standard IEC103.
 - Automatically assigns RS485 addresses to the connected Huawei inverters and PID modules, and allows for RS485 address adjustment based on ESNs to facilitate remote configuration and maintenance.
 - Supports remote configuration of inverter parameters over the embedded WebUI and synchronizes the parameters from one inverter to other inverters in batches.
 - Automatically collects the data generated during the communication disconnection from the inverter or manually collects the data over the embedded WebUI after the connection resumes.
- Remote maintenance
 - Simultaneously connects to multiple NMSs (including Huawei and third-party NMSs) over Modbus-TCP and IEC104. Huawei NMS features centralized O&M, big data analytics, intelligent diagnosis, and mobile O&M.
 - Supports connection to a third-party NMS over File Transfer Protocol (FTP).
 - Sends electricity yield and alarms to users by emails.
- Grid scheduling
 - The SmartLogger supports various power grid scheduling modes and therefore can meet the requirements of power grid companies in different countries.
 - Implements rapid active power control and reactive power compensation for all the inverters connecting to the SmartLogger.

2.2 Appearance

Front View of the Shell

Figure 2-1 SmartLogger front view (unit: mm)

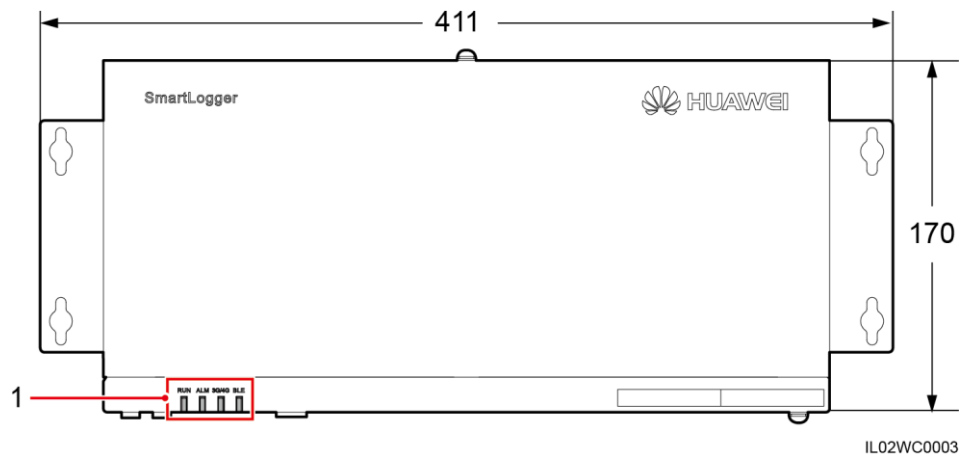

(1) LEDs

Table 2-1 Description of the LED indicators (from left to right)

Indicator (Silk Screen)	Status	Meaning	
RUN indicator (RUN)	Green off	The SmartLogger is not powered on.	
	Blinking green at short intervals (on for 0.125s and then off for 0.125s)	The SmartLogger and NMS (Huawei NMS or a third-party NMS) are not connected or the communication between them is interrupted.	
	Blinking green at long intervals (on for 1s and then off for 1s)	The SmartLogger properly communicates with the NMS (Huawei NMS or a third-party NMS).	
Alarm/maintenance indicator (ALM) ^a	Alarm status	Red off	The SmartLogger and the devices accessing it do not generate any alarm.
		Blinking red at long intervals (on for 1s and then off for 4s)	The SmartLogger or the devices accessing it generate warning alarms.
		Blinking red at short intervals (on for 0.5s and then off for 0.5s)	The SmartLogger or the devices accessing it generate minor alarms.

Indicator (Silk Screen)	Status	Meaning	
		Steady red	The SmartLogger or the devices accessing it generate major alarms.
	Maintenance status	Green off	No local maintenance is underway ^b .
		Blinking green at long intervals (on for 1s and then off for 1s)	Local maintenance is in progress.
		Steady green	Local maintenance succeeds.
		Blinking green at short intervals (on for 0.125s and then off for 0.125s)	Local maintenance fails.
3G/4G indicator (3G/4G)	N/A	Reserved	
Bluetooth indicator (BLE)	Green off	You have not logged in to the APP or login failed. The SmartLogger is not connected to the APP or the communication has been interrupted ^c .	
	Blinking green at long intervals (on for 1s and then off for 1s)	You have successfully logged in to the APP.	
<p>a: If an alarm and local maintenance happen concurrently, the alarm/maintenance indicator shows the near-end maintenance state first. After the USB flash drive is removed, the indicator shows the alarm state.</p> <p>b: Local maintenance refers to operations performed by connecting a USB flash drive to the SmartLogger USB port, such as full data import and export using a USB flash drive.</p> <p>c: After the communication between the SmartLogger and the APP fails, the disconnection is normal if the green indicator goes off immediately, and is abnormal if the indicator goes off after blinking slowly for 30s.</p>			

Side View of the Shell

Figure 2-2 SmartLogger side view (unit: mm)

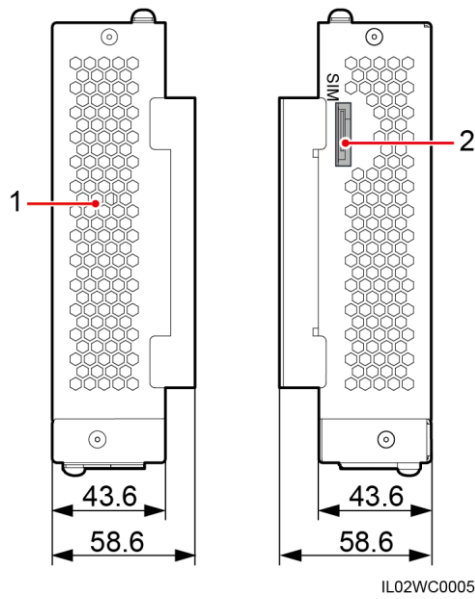

(1) Heat emission hole

(2) SIM card slot (for the SmartLogger2000-10/10-B/11-B only, reserved)

Rear View of the Shell

Figure 2-3 SmartLogger rear view (unit: mm)

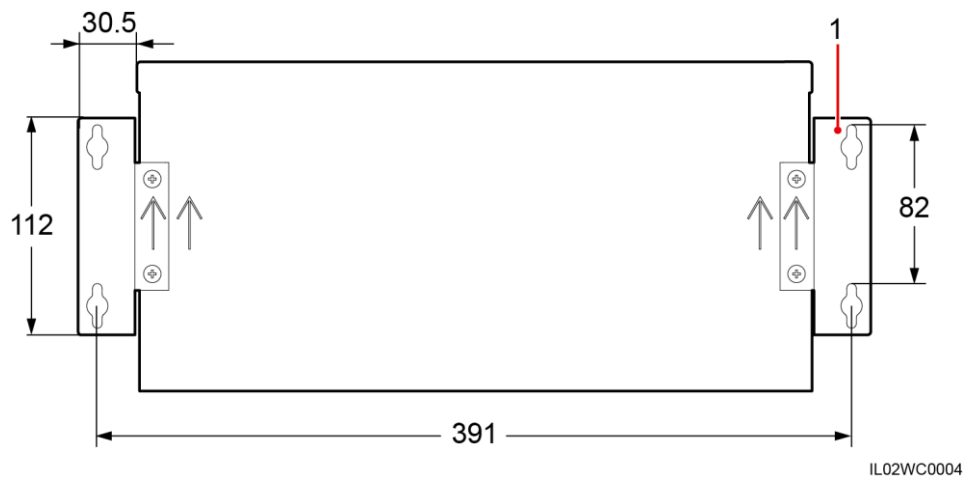

(1) Wall-mounting ears

Bottom of the Shell

Figure 2-4 SmartLogger2000-10/10-B/11-B bottom

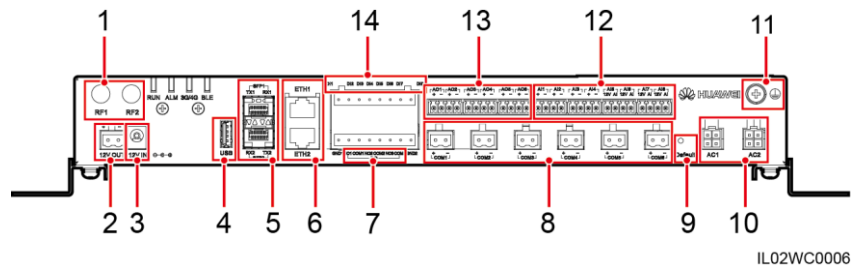

IL02WC0006

Table 2-2 Port description

No.	Port (Silk Screen)	Function	Description
1	RF1, RF2	Reserved	Reserved.
2	12V OUT	12 V DC output	Provides 12 V DC power supply with a maximum current of 100 mA.
3	12V IN	12 V DC input	Connects to a power adapter.
4	USB	USB port	Connects to a USB flash drive.
5	SFP1, SFP2	Ethernet optical port	Connects to an Access Terminal Box (ATB) or another cascaded SmartLogger.
6	ETH1, ETH2	Ethernet electrical port	Connects to an Ethernet switch, router, POE module, or PC.
7	DO	Digital parameter output	Relay output; supports the voltage of 12 V and current of 0.5 A.
8	COM1–COM6	RS485 communication	Six RS485 ports that can be connected to devices such as the inverter, box-type transformer, electricity meter, or EMI
9	Default	Default key	Resets and restarts the Bluetooth module or resets the SmartLogger IP address to the default IP address ^a . The default IP address is 192.168.0.10.
10	AC1, AC2	AC power cable ports	<ul style="list-style-type: none"> SmartLogger2000-10/10-B: Connects to the A, B, and C three-phase inputs, and used for MBUS (PLC) with the SUN2000 over AC

No.	Port (Silk Screen)	Function	Description
			power cables. If MBUS (PLC) function is not used, you do not have to connect cables to these ports. <ul style="list-style-type: none"> SmartLogger2000-11-B: disabled
11		External grounding	N/A
12	AI1–AI8	Analog input	<ul style="list-style-type: none"> SmartLogger2000-10: AI1–AI4 support 4–20 mA and 0–20 mA current input (passive^b); AI5–AI8 support 4–20 mA and 0–20 mA current input (active^c). SmartLogger2000-10-B/11-B: AI1 supports 0–10 V voltage input (passive); AI2–AI4 support 4–20 mA and 0–20 mA current input (passive). AI5–AI8 support 4–20 mA and 0–20 mA current input (active).
13	AO1–AO6	Analog output	4–20 mA and 0–20 mA current output
14	DI1–DI8	Digital parameter input	Connects to a dry contact input. GND1 and GND2 are grounding ports for DI signals.

a:

- If the APP fails to connect to the SmartLogger or you have forgotten the IP address, you can press the Default key to reset the Bluetooth module or restore the IP address to the default IP address (192.168.0.10).
- Press and hold down the Default key for 3s to 10s to reset and restart the Bluetooth module. Press and hold down the Default key for 3s to 10s until the BLU indicator blinks at short intervals (on for 0.125s and then off for 0.125s) and all the other indicators are off, and then release the Default key.
- Press and hold down for more than 10s to restore the IP address to the default IP address. Press and hold down the Default key for more than 10s until the RUN indicator blinks at short intervals (on for 0.125s and then off for 0.125s) and all the other indicators are off, and then release the Default key. The operation is valid within 5 minutes.

b: Passive means that the AI port supports the connection to a sensor that requires a separate external power supply.

c: Active means that the AI port supports the connection to a sensor that does not require a separate external power supply.

Figure 2-5 SmartLogger2000-10-C/11-C bottom

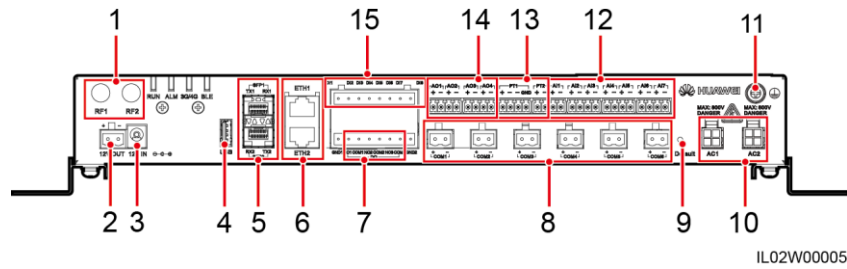

IL02W00005

Table 2-3 Port description

No.	Port (Silk Screen)	Function	Description
1	RF1, RF2	Reserved	Reserved.
2	12V OUT	12 V DC output	Provides 12 V DC power supply with a maximum current of 100 mA.
3	12V IN	12 V DC input	Connects to a power adapter.
4	USB	USB port	Connects to a USB flash drive.
5	SFP1, SFP2	Ethernet optical port	Connects to an ATB or another cascaded SmartLogger.
6	ETH1, ETH2	Ethernet electrical port	Connects to an Ethernet switch, router, POE module, or PC.
7	DO	Digital parameter output	Relay output; supports the voltage of 12 V and current of 0.5 A.
8	COM1–COM6	RS485 communication	Six RS485 ports that can be connected to devices such as the inverter, box-type transformer, electricity meter, or EMI
9	Default	Default key	Resets and restarts the Bluetooth module or resets the SmartLogger IP address to the default IP address ^a . The default IP address is 192.168.0.10.
10	AC1, AC2 ^b	AC power cable ports	<ul style="list-style-type: none"> SmartLogger2000-10-C: Connects to the A, B, and C three-phase inputs, and used for MBUS (PLC) with the SUN2000 over AC power cables. If MBUS (PLC) function is not used, you do not have to connect cables to these ports. SmartLogger2000-11-C: disabled
11		External grounding	N/A
12	AI1–AI7	Analog input	AI1 supports 0–10 V voltage input (passive ^c); AI2–AI7 support 0–20 mA and 4–20 mA current input (passive).

No.	Port (Silk Screen)	Function	Description
13	PT1, PT2	Analog input	<ul style="list-style-type: none"> PT1 supports the connection to a three-wire and two-wire PT100/PT1000 temperature sensor. PT2 supports the connection to only a two-wire PT100/PT1000 temperature sensor.
14	AO1–AO4	Analog output	4–20 mA and 0–20 mA current output
15	DI1–DI8	Digital parameter input	Connects to a dry contact input. GND1 and GND2 are grounding ports for DI signals.

a:

- If the APP fails to connect to the SmartLogger or you have forgotten the IP address, you can press the Default key to reset the Bluetooth module or restore the IP address to the default IP address (192.168.0.10).
- Press and hold down the Default key for 3s to 10s to reset and restart the Bluetooth module. Press and hold down the Default key for 3s to 10s until the BLU indicator blinks at short intervals (on for 0.125s and then off for 0.125s) and all the other indicators are off, and then release the Default key.
- Press and hold down for more than 10s to restore the IP address to the default IP address. Press and hold down the Default key for more than 10s until the RUN indicator blinks at short intervals (on for 0.125s and then off for 0.125s) and all the other indicators are off, and then release the Default key. The operation is valid within 5 minutes.

b: When the SmartLogger is applied in a non-smart array controller, connect the AC1 and AC2 ports to the SPD with the delivered cables. The residue voltage of the SPD should be less than 6 kV.

c: Passive means that the AI port supports the connection to a sensor that requires a separate external power supply.

2.3 Nameplate Description

A nameplate is attached at the back of the SmartLogger. The content of the nameplate includes the SmartLogger model, rated power specifications, and certification marks. [Figure 2-6](#) shows the nameplate of the SmartLogger2000-10-C.

Figure 2-6 Nameplate

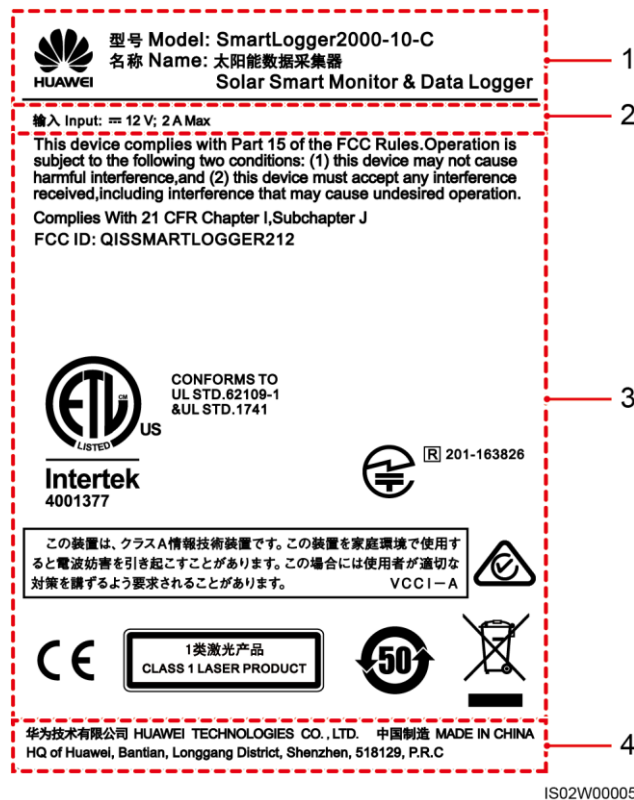





- (1) Trademark and product model
- (2) Rated power specifications
- (3) Compliance symbols
- (4) Company name and place of manufacture

NOTE

The nameplate figure is for reference only. The actual nameplate prevails.

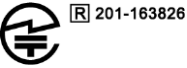
Table 2-4 Compliance symbols

Symbol	Name	Meaning
<p>This device complies with Part 15 of the FCC Rules. Operation is subject to the following two conditions: (1) this device may not cause harmful interference, and (2) this device must accept any interference received, including interference that may cause undesired operation.</p> <p>FCC ID: QISSMARTLOGGER212</p>	<p>U.S. FCC Part 15B, Part15C, and Part15G certification</p>	<p>This product complies with FCC Part 15B, Part15C, and Part15G certification standards.</p>
<p>Complies With 21 CFR Chapter I, Subchapter J</p>	<p>Compliance with American Food and Drug Administration (FDA) certification mark</p>	<p>This product complies with American FDA certification standards.</p>

Symbol	Name	Meaning
	Compliance with American Electrical Testing Laboratories (ETL) certification mark	This product complies with the 62109-1 and 1741 standards of American Underwriters laboratories (UL) certification.
	Japanese Telecom Engineering Center (TELEC) certification mark	This product complies with Japanese TELEC certification standards.
<div style="border: 1px solid black; padding: 5px; width: fit-content;"> <p>この装置は、クラスA情報技術装置です。この装置を家庭環境で使用すると電波妨害を引き起こすことがあります。この場合には使用者が適切な対策を講ずるよう要求されることがあります。 VCCI-A</p> </div>	Japanese Voluntary Control Council for Interference by Information Technology Equipment (VCCI) certification mark	This product complies with Japanese VCCI certification standards for class A products.
	Australia RCM certification	The product complies with Australia RCM certification standards.
	Conformité Européenne (CE) certification mark	This product complies with CE certification standards.
<div style="border: 1px solid black; padding: 5px; width: fit-content;"> <p>1类激光产品 CLASS 1 LASER PRODUCT</p> </div>	Class 1 laser certification mark	This product complies with class 1 laser certification standards.
	Environmentally friendly use period (EFUP) label	This product does not pollute the environment during a specified period.
	EU waste electrical and electronic equipment (WEEE) label	Do not dispose of the SmartLogger as household garbage. For details about how to deal with the undesirable SmartLogger, refer to 11 SmartLogger Disposal .

2.4 Typical Networking Scenarios

Fiber+RS485/MBUS Networking

A fiber network is classified into a ring network and a star network, as shown in [Figure 2-7](#) and [Figure 2-8](#) respectively.

In the fiber networking, the SmartLogger connects to an inverter over an RS485 communications cable or an AC power cable, connects to a box-type transformer over an RS485 communications cable or an Ethernet network cable, and connects to southbound devices such as the EMI and electricity meter over RS485 communications cables.

NOTE

The SmartLogger can work with the inverter equipped with the MBUS (PLC) STA module over an embedded or external SmartMBUS (PLC CCO) to implement MBUS networking over power cables.

Figure 2-7 Fiber ring network diagram

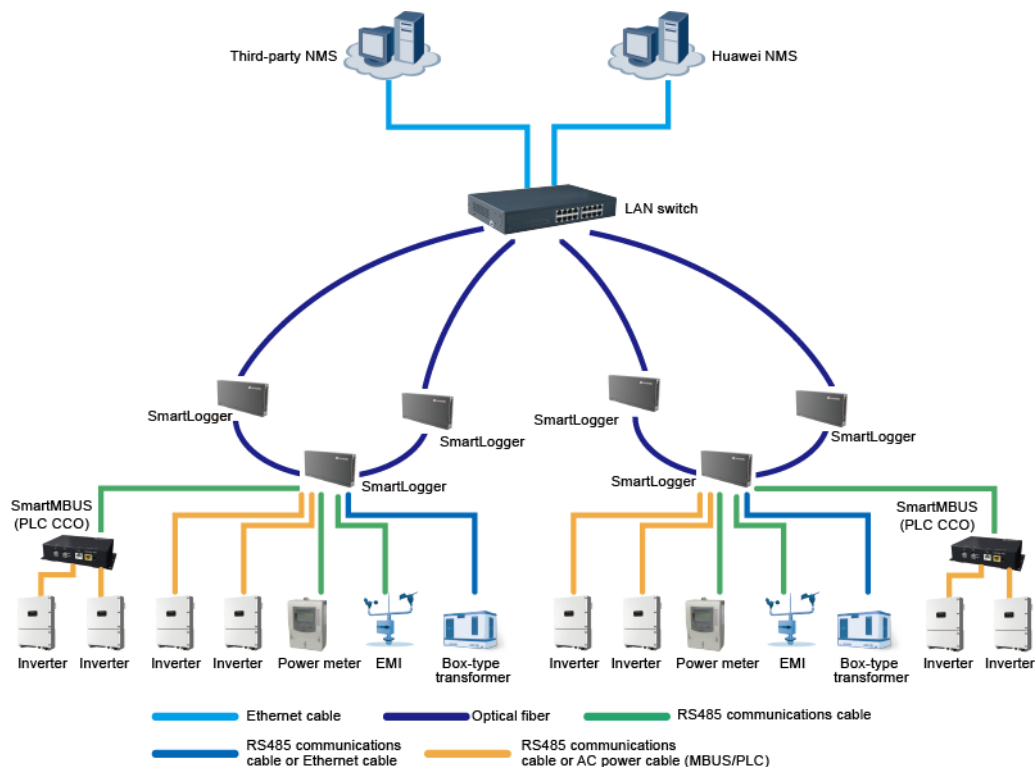

IL02N10007

NOTE

- The SmartLogger provides two 100M Ethernet optical ports to implement ring networking.
- A maximum of 15 SmartLoggers can be connected to form a fiber ring network. Each SmartLogger can connect to southbound devices such as the inverter, EMI, and electricity meter.
- Multiple fiber ring networks can converge over an Ethernet switch or SmartLogger and then connect to an NMS.

Figure 2-8 Fiber star network diagram

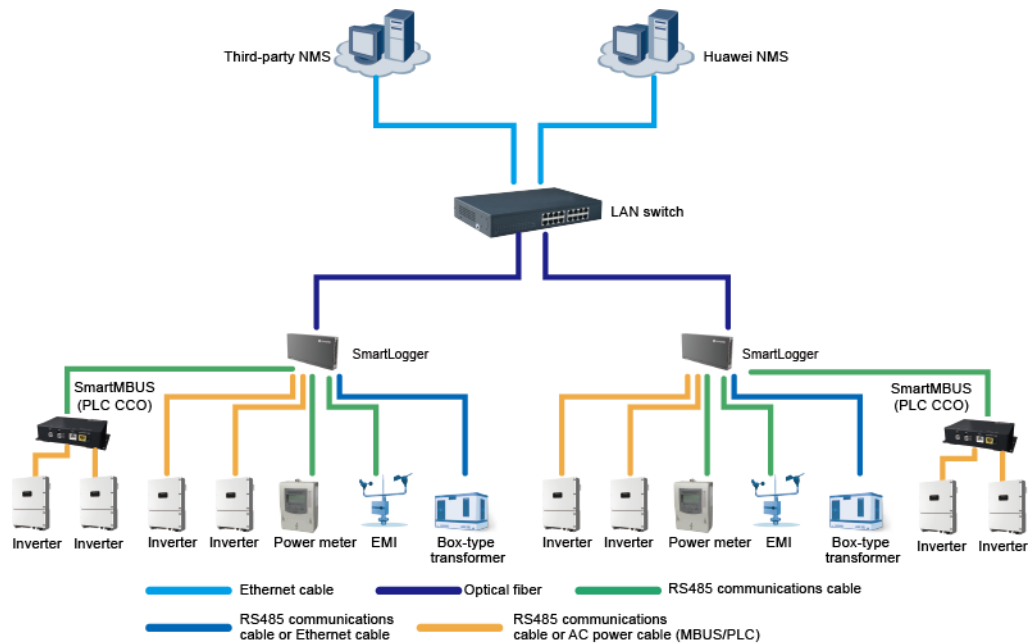

IL02N10008

NOTE

- Multiple SmartLoggers can converge over an Ethernet switch and then connect to an NMS.
- The SmartLogger connects to the Ethernet switch over optical fibers with the maximum communications distance of 12 km in between.

LTE+RS485/MBUS Networking

Figure 2-9 shows the LTE+RS485/MBUS network diagram.

In the LTE wireless networking scenario, the SmartLogger connects to the inverter over an RS485 communications cable or an AC power cable, connects to a box-type transformer over an RS485 communications cable or an Ethernet network cable, connects to southbound devices such as the EMI and electricity meter over RS485 communications cables, connects to customer-premises equipment (CPE) over an Ethernet electrical port, and transmits information collected from southbound devices to an NMS in wireless mode.

Figure 2-9 LTE+RS485/MBUS network diagram

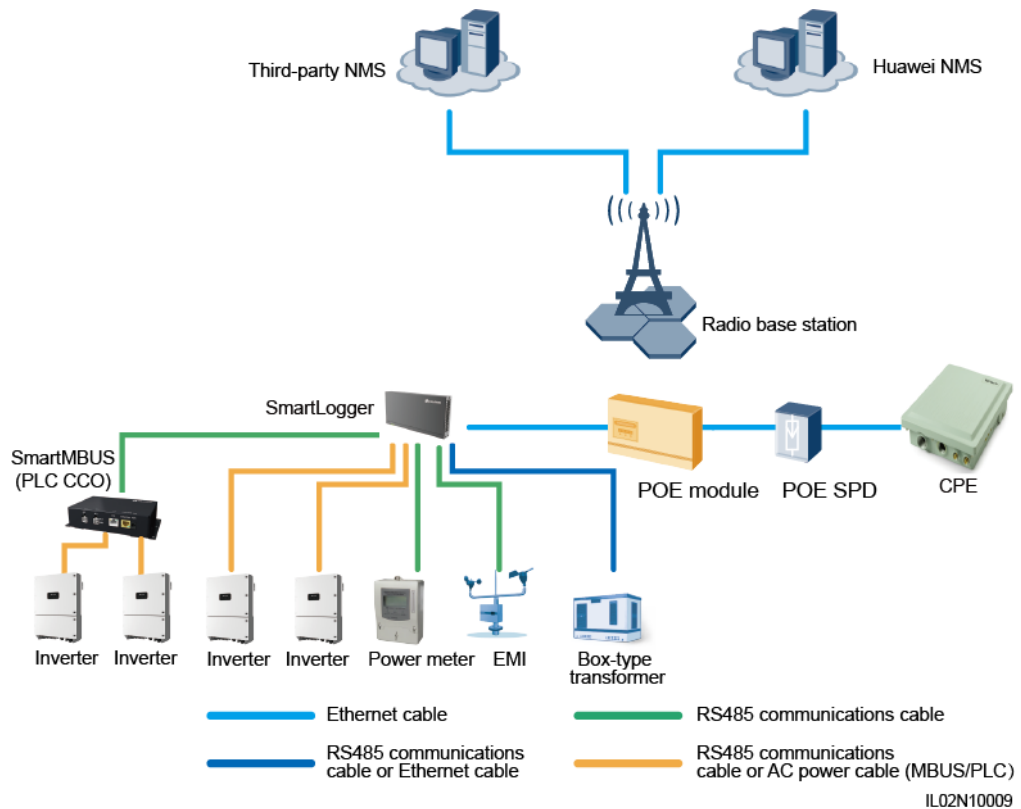

NOTE

- The IP addresses for the SmartLogger, CPE, and monitoring device in the box-type transformer must be in the same network segment.
- The IP address planned for the SmartLogger needs to be imported to the third-party NMS for the NMS to proactively connect to the SmartLogger.
- The IP address planned for the box-type transformer needs to be imported to the third-party NMS for the NMS to proactively connect to the box-type transformer.

2.5 System Wiring Diagram

Scenario with a Smart Array Controller

NOTE

- Huawei smart array controller, also a communication box, is an outdoor cabinet that controls the communication of the PV array in a PV plant. The cabinet can house the SmartLogger, ATB, and POE module.
- This document describes the application scenario where the SmartLogger is inside the smart array controller SmartACU2000B-D-2PID/2PLC.

NOTICE

- The single-phase AC power cable for the smart array controller needs to be prepared by the customer. You are advised to use a two-core outdoor armor copper cable with an operating voltage to the ground greater than or equal to 300 V and a cross-sectional area of 4 mm² for each core wire.
- The power cable from the miniature circuit breaker (MCB) to the station-service power source needs to be prepared by the customer. You are advised to use a two-core outdoor armor copper cable with an operating voltage to the ground greater than or equal to 300 V and a cross-sectional area of 4 mm² for each core wire.
- The three-phase AC power cable for the smart array controller needs to be prepared by the customer. You are advised to use a four-core (L1, L2, L3, and functional earthing) outdoor armor copper cable with a cross-sectional area of 10 mm² for each core wire as the three-phase AC power cable. When the rated AC voltage on the low-voltage side of the box-type transformer is less than or equal to 500 V, the operating voltage to the ground of the three-phase AC power cable should be greater than or equal to 600 V. When the rated AC voltage on the low-voltage side of the box-type transformer is greater than 500 V and less than or equal to 800 V, the operating voltage to the ground of the three-phase AC power cable should be greater than or equal to 1000 V.
- The cable from the busbar to the three-phase power switch needs to be prepared by the customer. You are advised to use a four-core multi-wire (L1, L2, L3, and functional earthing) outdoor armor cable with a cross-sectional area of 10 mm² for each core wire as the cable from the busbar to the knife switch. When the rated AC voltage on the low-voltage side of the box-type transformer is less than or equal to 500 V, the operating voltage to the ground of the cable should be greater than or equal to 600 V. When the rated AC voltage on the low-voltage side of the box-type transformer is greater than 500 V and less than or equal to 800 V, the operating voltage to the ground of the cable should be greater than or equal to 1000 V.

Figure 2-10 Fiber ring network

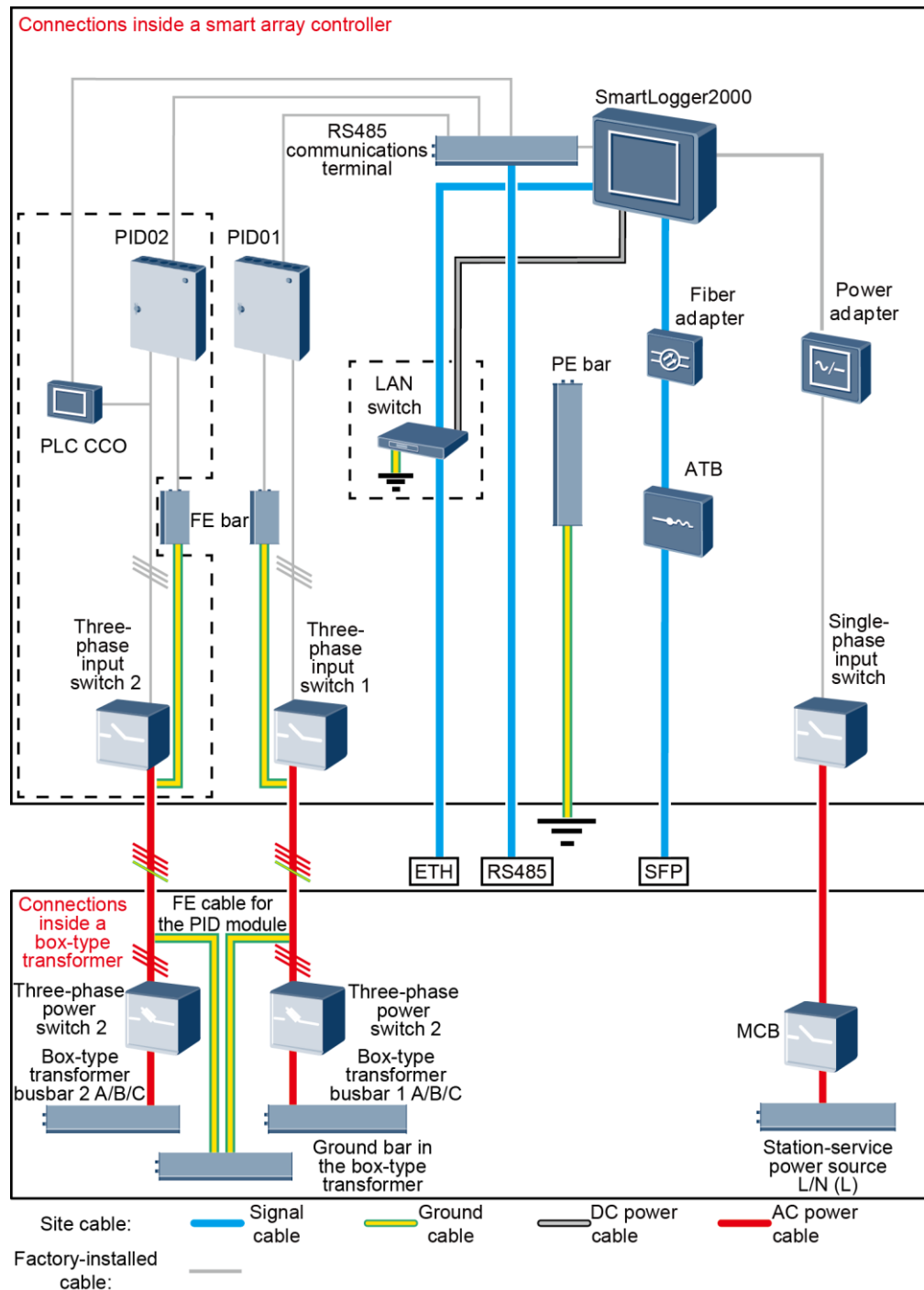

NOTE

Components in dashed-line boxes are optional. To highlight the involved area, the figure does not show all factory-installed components and cables.

Table 2-5 lists the components required for the fiber networking mode in the scenario with a smart array controller.

Table 2-5 Components required

Location	Component		Recommended Model or Specifications	Source of Component	Quantity
Smart array controller	(Optional) LAN switch		UT-H605 or ES1000	Can be purchased from Huawei	1
	Fitting bag for fiber ring switching	Low-speed optical module	FTLF1323P1BTR-HW	Can be purchased from Huawei	2
		Optical jumper	PLCLC5S-ST3P302-HW, LC-LC-S2-L2, 3ECA1031LCLC002-01-F, or LP-LP-2S-P-SM-002		8
Box-type transformer	MCB		Rated current: 32 A; number of poles: 2	Prepared by the customer	1
	Three-phase power switch	Knife fuse switch (solution 1)	<ul style="list-style-type: none"> When the rated AC voltage on the low-voltage side of the box-type transformer is less than or equal to 500 V, the rated voltage should be greater than or equal to 500 V; when the rated AC voltage on the low-voltage side of the box-type transformer is greater than 500 V and less than or equal to 800 V, the rated voltage should be greater than or equal to 800 V Rated current of the fuse: 32 A; rated current of the knife fuse switch box ≥ 32 A; number of poles: 3 (3 fuses for each knife fuse switch box) 	Prepared by the customer	<ul style="list-style-type: none"> Scenario with a double-column transformer: 1 Scenario with a dual-split transformer: 2
		MCCB (solution 2)	<ul style="list-style-type: none"> When the rated AC voltage on the low-voltage side of the box-type transformer is less than or equal to 500 V, the rated voltage should be greater than or equal to 500 V; when the rated AC voltage on the low-voltage side of the box-type transformer is greater than 500 V and less than or equal to 800 V, the rated voltage should be greater than or equal to 800 V Let-through energy ≤ 1.26 x 		

Location	Component	Recommended Model or Specifications	Source of Component	Quantity
		10 ⁶ A ² s <ul style="list-style-type: none">Rated current: 32 A; number of poles: 3		

Figure 2-11 4G LTE

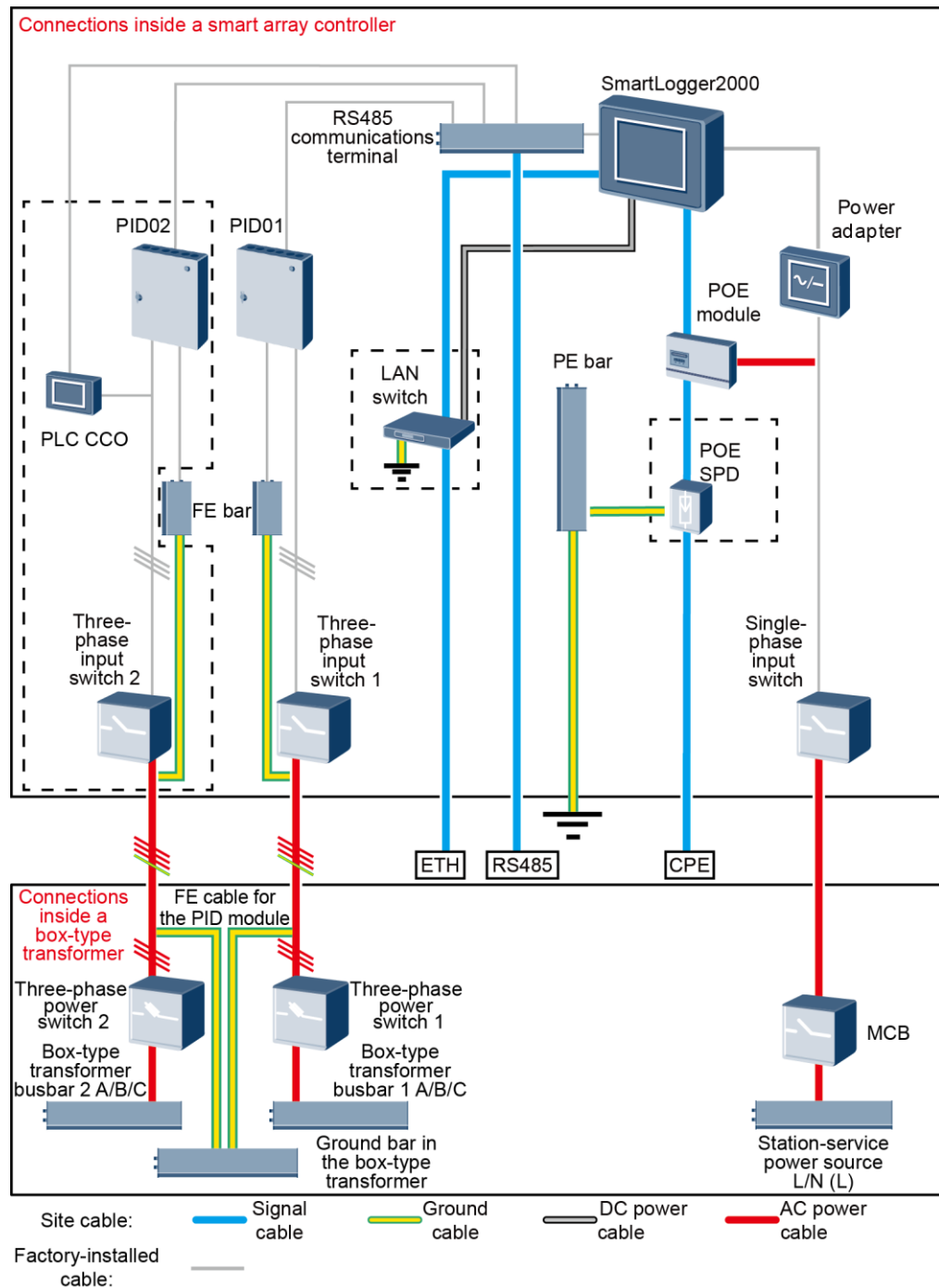

NOTE

Components in dashed-line boxes are optional. To highlight the involved area, the figure does not show all factory-installed components and cables.

Table 2-6 lists the components required for the 4G LTE networking mode in the scenario with a smart array controller.

Table 2-6 Components required

Location	Component		Recommended Model or Specifications	Source of Component	Quantity
Smart array controller	(Optional) LAN switch		UT-H605 or ES1000	Can be purchased from Huawei	1
	POE and CPE fitting bags	POE module	N/A	Can be purchased from Huawei	1
Outside the smart array controller and box-type transformer		CPE ^a	N/A	Can be purchased from Huawei	1
Box-type transformer	MCB		Rated current: 32 A; number of poles: 2	Prepared by the customer	1
	Three-phase power switch	Knife fuse switch (solution 1)	<ul style="list-style-type: none"> When the rated AC voltage on the low-voltage side of the box-type transformer is less than or equal to 500 V, the rated voltage should be greater than or equal to 500 V; when the rated AC voltage on the low-voltage side of the box-type transformer is greater than 500 V and less than or equal to 800 V, the rated voltage should be greater than or equal to 800 V Rated current of the fuse: 32 A; rated current of the knife fuse switch box \geq 32 A; number of poles: 3 (3 fuses for each knife fuse switch box) 	Prepared by the customer	<ul style="list-style-type: none"> Scenario with a double-column transformer: 1 Scenario with a dual-split transformer: 2
		MCCB (solution 2)	<ul style="list-style-type: none"> When the rated AC voltage on the low-voltage side of the box-type transformer is less than or equal to 500 V, the rated voltage should be greater than or equal to 500 V; when the rated AC voltage on the low-voltage side of the box-type transformer is greater than 500 V and less than or equal to 800 V, the rated voltage should be greater than or equal to 800 V 	Prepared by the customer	

Location	Component	Recommended Model or Specifications	Source of Component	Quantity
		<ul style="list-style-type: none"> • Let-through energy $\leq 1.26 \times 10^6 \text{ A}^2\text{s}$ • Rated current: 32 A; number of poles: 3 		
<p>a: If the CPE is EG860 series, the POE and CPE fitting bags are configured with a POE SPD.</p>				

Scenario Without a Smart Array Controller

NOTICE

- If the SmartLogger uses an AC power cable for communication, an MCB or a knife fuse switch needs to be installed to prevent device damage in the case of short circuits.
- If the SmartLogger communicates with a inverter over an AC power cable, both the cable from the knife switch to the MCB and the cable from the busbar to the knife switch need to be prepared by the customer. You are advised to use a three-core multi-wire outdoor armor cable with a cross-sectional area of 10 mm² for each core wire. When the rated AC voltage on the low-voltage side of the box-type transformer is less than or equal to 500 V, the operating voltage to the ground of the AC power cable should be greater than or equal to 600 V. When the rated AC voltage on the low-voltage side of the box-type transformer is greater than 500 V and less than or equal to 800 V, the operating voltage to the ground of the AC power cable should be greater than or equal to 1000 V.
- The SmartLogger can connect to the inverter over an RS485 communications cable or AC power cable. If RS485 is used, there is no need to connect an AC power cable between the SmartLogger and the MCB in the scenario without a smart array controller.
- The power cable delivered with the SmartLogger is 1 m long, the power adapter cable is 1.5 m long, the network cable is 2.2 m long, and the AC power cable is 1.5 m long. Reserve the installation positions for components based on the cable lengths.

Figure 2-12 Fiber ring network

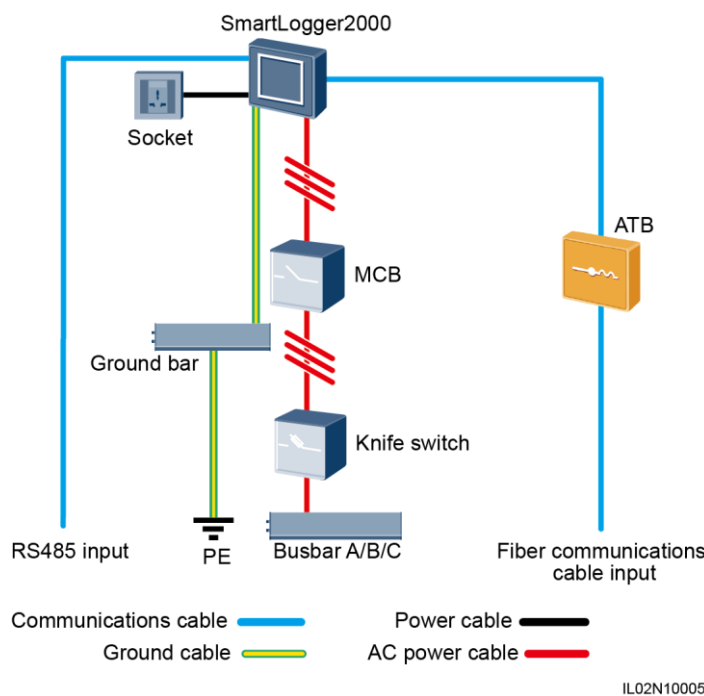

Table 2-7 lists the components required for the fiber networking mode in the scenario without a smart array controller.

Table 2-7 Components required

Component	Recommended Model or Specifications	Source of Component	Quantity
-----------	-------------------------------------	---------------------	----------

Component		Recommended Model or Specifications	Source of Component	Quantity
SmartLogger		SmartLogger2000	Can be purchased from Huawei	1
Fitting bag for fiber ring switching	Low-speed optical module	FTLF1323P1BTR-HW	Can be purchased from Huawei	2
	Optical jumper	PLCLC5S-ST3P302-HW, LC-LC-S2-L2, 3ECA1031LCLC002-01-F, or LP-LP-2S-P-SM-002	Can be purchased from Huawei	8
ATB		CT-GZF2PJ-8, CT-GPH-A-8, or an ATB of a local model	Prepared by the customer	1
Knife switch	Fuse	<ul style="list-style-type: none"> When the rated AC voltage on the low-voltage side of the box-type transformer is less than or equal to 500 V, the rated voltage should be greater than or equal to 500 V; when the rated AC voltage on the low-voltage side of the box-type transformer is greater than 500 V and less than or equal to 800 V, the rated voltage should be greater than or equal to 800 V When the rated AC voltage on the low-voltage side of the box-type transformer is less than or equal to 500 V, the rated current should be greater than or equal to 6 A; when the rated AC voltage on the low-voltage side of the box-type transformer is greater than 500 V and less than or equal to 800 V, the rated current should be greater than or equal to 32 A 	Prepared by the customer	3
	Knife switch box	<ul style="list-style-type: none"> When the rated AC voltage on the low-voltage side of the box-type transformer is less than or equal to 500 V, the rated voltage should be greater than or equal to 500 V; when the rated AC voltage on the low-voltage side of the box-type transformer is greater than 500 V and less than or equal to 800 V, the rated voltage should be greater than or equal to 800 V When the rated AC voltage on the low-voltage side of the box-type transformer is less than or equal to 500 V, the rated current should be 	Prepared by the customer	1

Component	Recommended Model or Specifications	Source of Component	Quantity
	<p>greater than or equal to 6 A; when the rated AC voltage on the low-voltage side of the box-type transformer is greater than 500 V and less than or equal to 800 V, the rated current should be greater than or equal to 32 A; number of poles: 3</p>		
MCB	<ul style="list-style-type: none"> When the rated AC voltage on the low-voltage side of the box-type transformer is less than or equal to 500 V, the rated voltage should be greater than or equal to 500 V; when the rated AC voltage on the low-voltage side of the box-type transformer is greater than 500 V and less than or equal to 800 V, the rated voltage should be greater than or equal to 800 V When the rated AC voltage on the low-voltage side of the box-type transformer is less than or equal to 500 V, the rated current is greater than or equal to 6 A and less than or equal to 32 A; when the rated AC voltage on the low-voltage side of the box-type transformer is greater than 500 V and less than or equal to 800 V, the rated current is 32 A 	Prepared by the customer	1
Socket	Matching with the power adapter	Prepared by the customer	1

 **NOTE**

Length of the cable used for connecting components depends on the survey result.

Figure 2-13 4G LTE

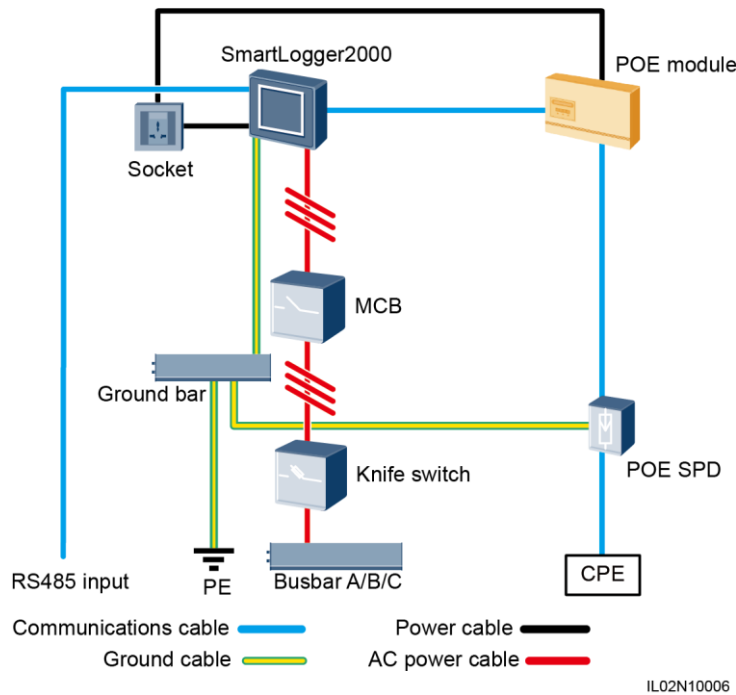

Table 2-8 lists the components required for the 4G LTE networking mode in the scenario without a smart array controller.

Table 2-8 Components required

Component		Recommended Model or Specifications	Source of Component	Quantity
SmartLogger		SmartLogger2000	Can be purchased from Huawei	1
POE module		POE35-54A or POE85-56A	Can be purchased from Huawei	1
POE SPD		POE-2	Can be purchased from Huawei	1
CPE		EG860V2-C71	Can be purchased from Huawei	1
Knife switch	Fuse	<ul style="list-style-type: none"> When the rated AC voltage on the low-voltage side of the box-type transformer is less than or equal to 500 V, the rated voltage should be greater than or equal to 500 V; when the rated AC voltage on the low-voltage side of the box-type transformer is greater than 500 V and less than or equal to 800 V, the rated voltage should be greater than or equal to 800 V 	Prepared by the customer	3

Component		Recommended Model or Specifications	Source of Component	Quantity
		<ul style="list-style-type: none"> When the rated AC voltage on the low-voltage side of the box-type transformer is less than or equal to 500 V, the rated current should be greater than or equal to 6 A; when the rated AC voltage on the low-voltage side of the box-type transformer is greater than 500 V and less than or equal to 800 V, the rated current should be greater than or equal to 32 A 		
	Knife switch box	<ul style="list-style-type: none"> When the rated AC voltage on the low-voltage side of the box-type transformer is less than or equal to 500 V, the rated voltage should be greater than or equal to 500 V; when the rated AC voltage on the low-voltage side of the box-type transformer is greater than 500 V and less than or equal to 800 V, the rated voltage should be greater than or equal to 800 V When the rated AC voltage on the low-voltage side of the box-type transformer is less than or equal to 500 V, the rated current should be greater than or equal to 6 A; when the rated AC voltage on the low-voltage side of the box-type transformer is greater than 500 V and less than or equal to 800 V, the rated current should be greater than or equal to 32 A; number of poles: 3 	Prepared by the customer	1
MCB		<ul style="list-style-type: none"> When the rated AC voltage on the low-voltage side of the box-type transformer is less than or equal to 500 V, the rated voltage should be greater than or equal to 500 V; when the rated AC voltage on the low-voltage side of the box-type transformer is greater than 500 V and less than or equal to 800 V, the rated voltage should be greater than or equal to 800 V When the rated AC voltage on the low-voltage side of the box-type transformer is less than or equal to 500 V, the rated current is greater than or equal to 6 A and less than 	Prepared by the customer	1

Component	Recommended Model or Specifications	Source of Component	Quantity
	or equal to 32 A; when the rated AC voltage on the low-voltage side of the box-type transformer is greater than 500 V and less than or equal to 800 V, the rated current is 32 A		
Socket	Matching with the power adapter	Prepared by the customer	1

 **NOTE**

Length of the cable used for connecting components depends on the survey result.

3 Device Installation

3.1 Precautions

Install the SmartLogger in an appropriate position and on a suitable surface.

 **DANGER**

- Do not install the SmartLogger in areas with flammable or explosive materials.
 - Do not install the SmartLogger on flammable building materials.
-

3.2 Checking Before Installation

Checking the Outer Packing

Before unpacking the SmartLogger, check the outer packing for damage, such as holes and cracks. If any damage is found, do not unpack the SmartLogger and contact the dealer immediately.

Checking the Product and Accessories



After unpacking the SmartLogger, check that the product and accessories are intact and complete, and free from any obvious damage. Contact the dealer if any damage is found or any component is missing.





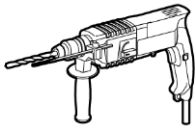
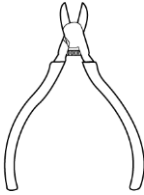
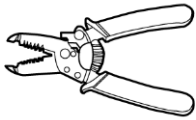
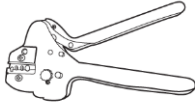
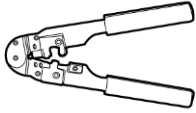

 **NOTE**



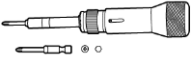

For details about the number of accessories delivered with the SmartLogger, see the *Packing List* in the packing case.

3.3 Tools

Tool	Model	Used To
------	-------	---------

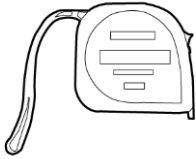
Tool	Model	Used To
<p>Hammer drill</p> 	<p>Drill bit (Φ6 mm)</p>	<p>Drill holes in the wall when the SmartLogger is wall-mounted.</p>
<p>Diagonal pliers</p> 	<p>N/A</p>	<p>Cut cable ties.</p>
<p>Wire stripper</p> 	<p>N/A</p>	<p>Peel off cable jackets.</p>
<p>Crimping tool</p> 	<p>H4TC0001 Manufacturer: Amphenol</p>	<p>Crimp cables.</p>
<p>RJ45 crimping tool</p> 	<p>N/A</p>	<p>Crimp RJ45 plug connectors for communications cables.</p>
<p>Flat-head screwdriver</p> 	<p>3x100</p>	<p>Tighten screws on the cable terminal block.</p>
<p>Torque screwdriver</p>	<p>Phillips head: M4 and ST3.5</p>	<p>Tighten screws during device installation.</p>

Tool	Model	Used To
		
<p>Rubber mallet</p> 	N/A	Hammer expansion sleeves into holes.
<p>Utility knife</p> 	N/A	Remove packing.
<p>Wire clippers</p> 	N/A	Cut cables.
<p>Vacuum cleaner</p> 	N/A	Clean up dust after holes are drilled.
<p>Marker</p> 	Diameter: ≤ 10 mm	Mark signs.
<p>Measuring tape</p>	N/A	Measure distances.

Tool	Model	Used To
		
Safety goggles 	N/A	Protect the operator's eyes from dust during hole drilling.
Anti-dust respirator 	N/A	Protect an operator from dust inhalation during hole drilling.
Heat gun 	N/A	Heat-shrink a tube.
Cable tie 	N/A	Bind cables.

3.4 Determining the Installation Position

Comply with the following requirements when determining the installation position for the SmartLogger:

- The SmartLogger has a protection level of IP20. It cannot be installed outdoors.
- The SmartLogger should be installed in a dry environment to protect it from water.
- The ambient temperature should be within the range of -40°C to $+60^{\circ}\text{C}$. Avoid exposing the SmartLogger to direct sunlight.

- The communications distance must not exceed 1000 m for the RS485 port, and must not exceed 100 m for the Ethernet port.
- The SmartLogger should be installed at a proper height to facilitate operation and maintenance.
- Do not place the SmartLogger upside down; otherwise, dust will fall into ports at the bottom of the SmartLogger, thereby reducing the service life.
- The installation mode and position must be suitable for the SmartLogger weight and dimensions with mounting ears (H x W x D: 411 mm x 170 mm x 58.6 mm).
- If the SmartLogger is installed on a wall or along a guide rail, the area for connecting cables should face downwards.
- [Figure 3-1](#) and [Figure 3-2](#) show the minimum distance between the SmartLogger and surrounding objects.

Figure 3-1 Minimum distance for wall mounting (unit: mm)

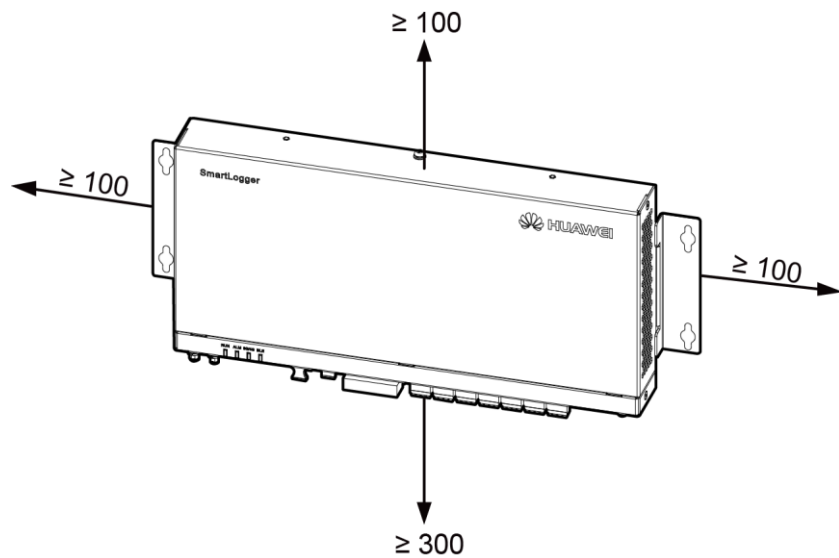

IL01SC0004

Figure 3-2 Minimum distance for guide rail mounting (unit: mm)

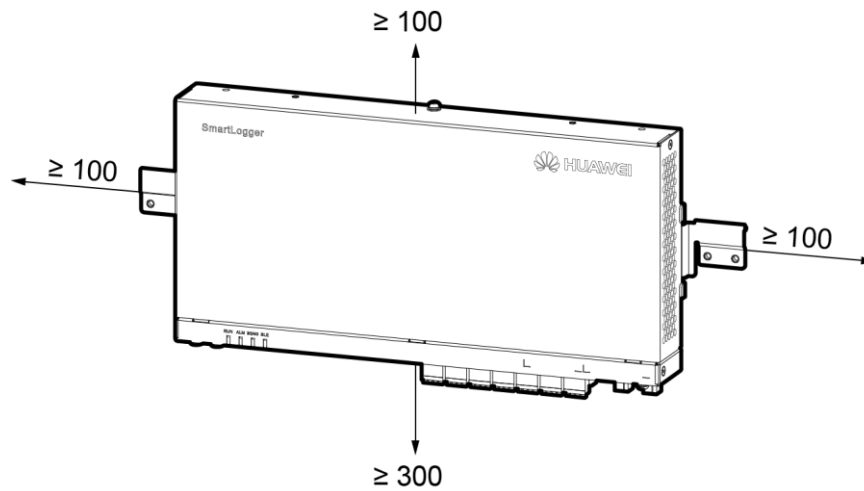

IL02S00001

3.5 Installing a SmartLogger

Context

In a scenario with a smart array controller, the SmartLogger is installed before delivery. In a scenario without a smart array controller, the SmartLogger can be installed on a wall or along a guide rail.

3.5.1 Installing a SmartLogger on a Wall

Context

NOTICE

- Choose a solid and smooth wall to ensure that the SmartLogger can be installed securely on the wall.
- Before hanging the SmartLogger on the screws, secure the expansion sleeves, washers, and tapping screws into the wall.

Figure 3-3 Distance between the screw holes in the mounting ears for the SmartLogger (unit: mm)

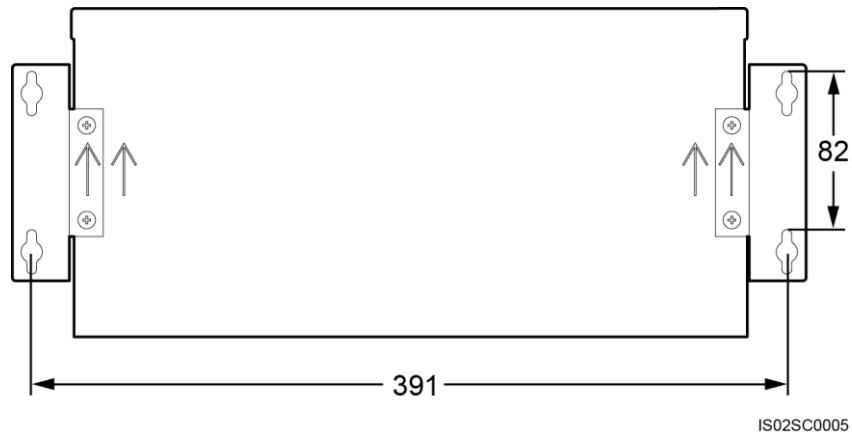
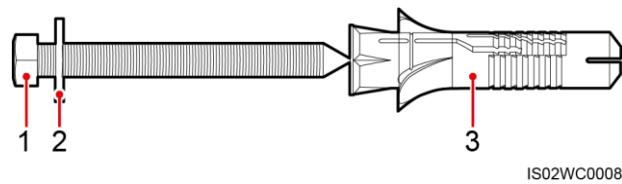

Figure 3-4 Screw assembly for wall-mounted installation



(1) ST3.5 tapping screw

(2) Washer

(3) Expansion sleeve

Procedure

- Step 1** Determine mounting holes based on the hole positions in the mounting ears, and mark the mounting holes using a marker.

⚠ DANGER

Avoid drilling holes in the water pipes and power cables buried in the wall.

NOTICE

If you need to use a ladder to install the SmartLogger on a high position, keep balance to protect yourself from falling down.

Figure 3-5 Hole positions and distance (unit: mm)

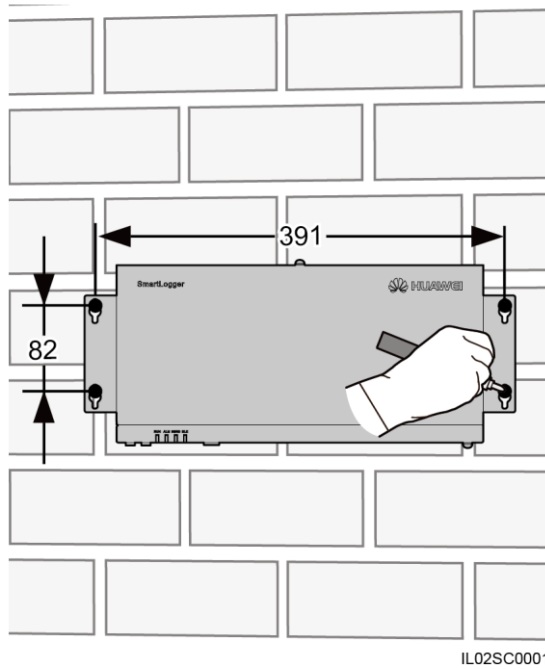

Step 2 Drill holes by using a hammer drill and install expansion sleeves, washers, and tapping screws.

Figure 3-6 Drilling holes and installing expansion sleeves, washers, and tapping screws (unit: mm)

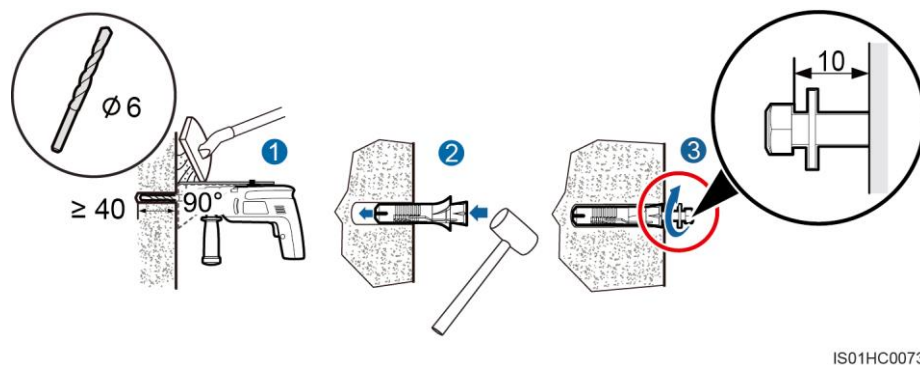

1. Put a hammer drill with a $\Phi 6$ mm drill bit on a marked hole position vertically against the wall and drill to a depth greater than or equal to 40 mm.

NOTICE

- To prevent dust inhalation or contact with eyes, the operator should wear an anti-dust respirator and safety goggles when drilling holes.
- Clean up any dust in and around the holes using a vacuum cleaner and measure the hole distance. If the holes are inaccurately positioned, drill holes again.

2. Slightly tighten the expansion sleeves, vertically insert them into holes, and knock them completely into the holes by using a rubber mallet.
3. Drive the tapping screws into the expansion sleeves, and reserve 10 mm outside of the holes.

Step 3 Put the tapping screws through the SmartLogger mounting ears and washers into the mounting holes in the wall.

NOTICE

When the SmartLogger is wall-mounted, ensure that the cable connection area faces downwards for ease of cable connection and maintenance.

Step 4 Tighten the tapping screws using a torque screwdriver.

Figure 3-7 Tightening the tapping screws

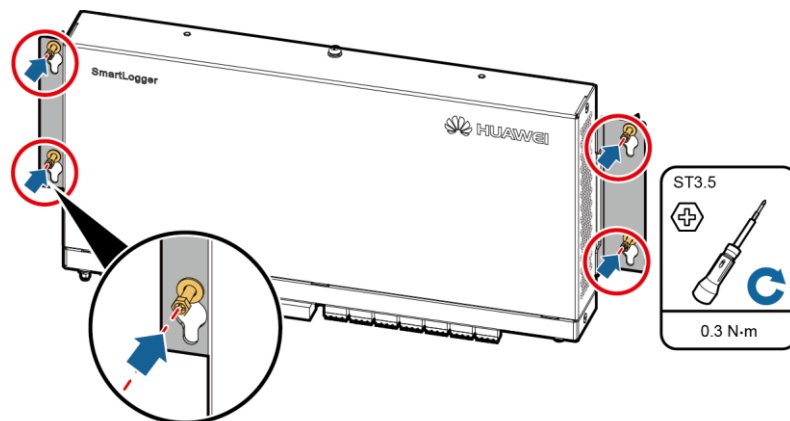

IL02HC0003

----End

3.5.2 Installing a SmartLogger Along a Guide Rail

Context

Huawei does not provide the SmartLogger guide rail. If you choose this installation mode, prepare a 35 mm standard guide rail by yourself.

Figure 3-8 Guide rail dimensions (unit: mm)

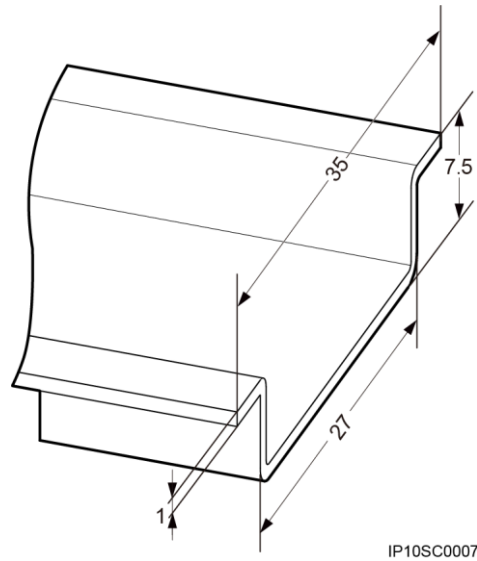

NOTICE

- Verify that the length of the guide rail is sufficient for securing the SmartLogger. The recommended length is 450 mm or greater.
- Ensure that the guide rail is secured before installing the SmartLogger.

Procedure

Step 1 Remove the mounting ears from the SmartLogger using a Phillips screwdriver.

Figure 3-9 Removing mounting ears

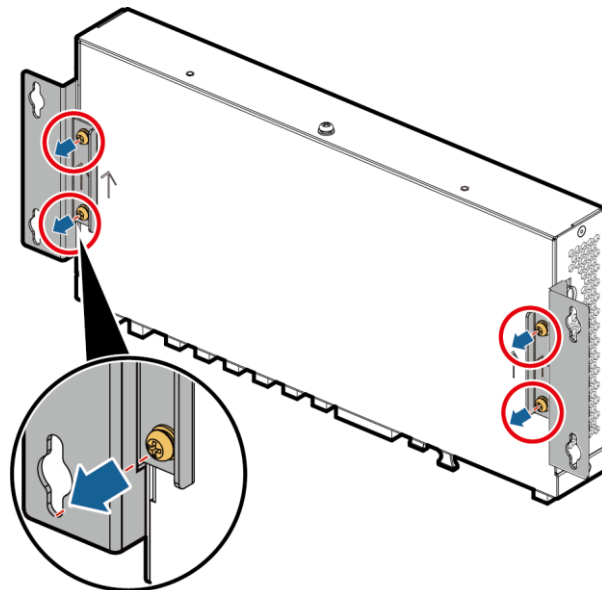

Step 2 Secure the guide rail clamps using the screws that are removed from the mounting ears.

NOTICE

Install the guide rail clamps exactly as shown in the figure; otherwise, you may not be able to mount the SmartLogger onto the guide rail.

Figure 3-10 Installing the guide rail clamps

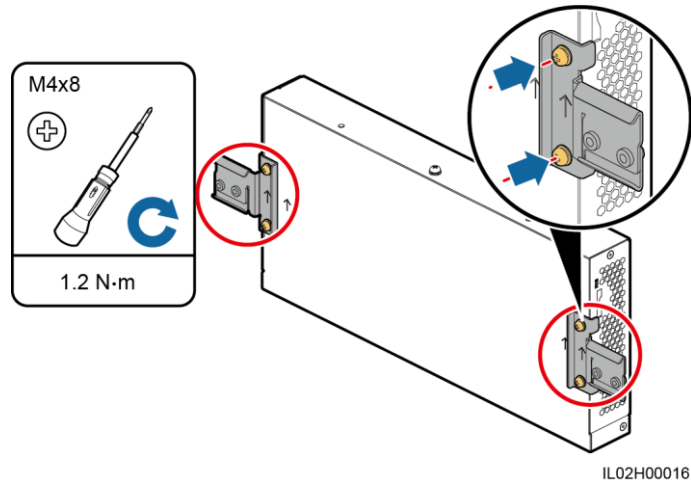

Step 3 Mount the SmartLogger onto the guide rail.

Figure 3-11 Mounting the SmartLogger onto the guide rail

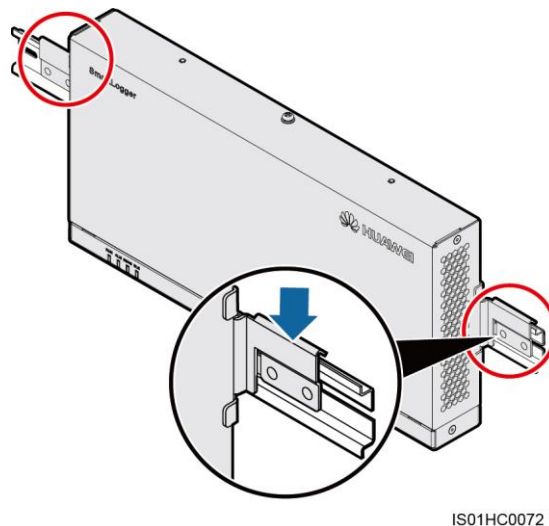

Step 4 Install guide rail fasteners.

Figure 3-12 Installing guide rail fasteners

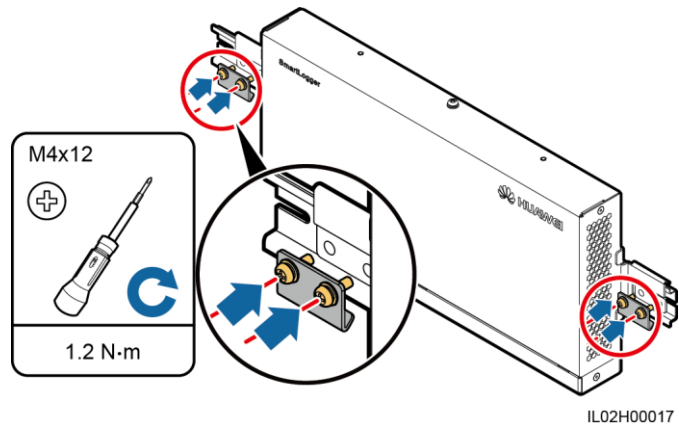

---End

4 Electrical Connection

4.1 Precautions

NOTE

- This section describes how to connect the SmartLogger to a inverter and other devices in the scenario without a smart array controller.
- In a scenario with a smart array controller, the SmartLogger is installed before delivery. Devices can connect to the SmartLogger over RS485 communications cables or AC power cables. For detailed operations, see the user manual for the appropriate smart array controller.
- The SmartLogger provides six COM ports to connect to RS485 communications cables. Connect Huawei equipment and third-party equipment to different COM ports if both of them need to connect to the SmartLogger. If only Huawei equipment or third-party equipment needs to connect to the SmartLogger, connect the equipment to an idle COM port.
- If the SmartLogger2000-10/10-B/11-B connects to equipment over an RS485 communications cable, an RS485 signal SPD is recommended. For details about installing and wiring the RS485 signal SPD, see [A Installing and Wiring the RS485 Signal SPD](#).
- If the SmartLogger2000-10-C/11-C connects to equipment over an RS485 communications cable, no RS485 signal SPD is required. This document uses the SmartLogger2000-10-C as an example to describe the cable connections.

NOTICE

- Ensure that all cables are connected securely.
- The SmartLogger has no start key. Before the electrical connections for the SmartLogger are complete, do not connect a power adapter to it.

4.2 Preparing an OT Terminal

[Figure 4-1](#) shows how to prepare an OT terminal.

Figure 4-1 Preparing an OT terminal

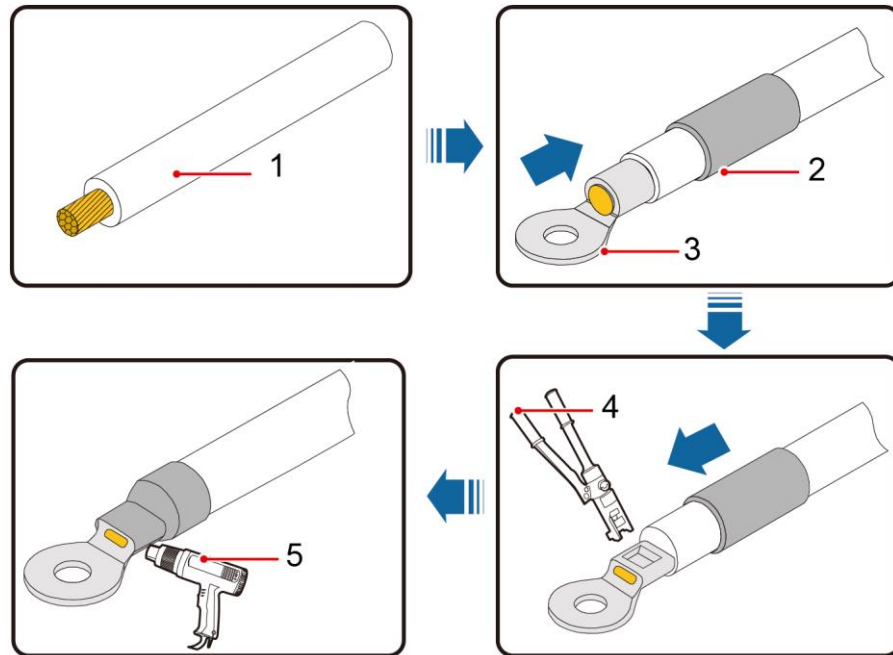

(1) Cable (2) Heat shrink tubing (3) OT terminal (4) Hydraulic pliers (5) Heat gun

4.3 Connecting Cables to the Terminal Block on the COM Port

Procedure

Step 1 Strip cables.

Figure 4-2 Stripping a cable (unit: mm)

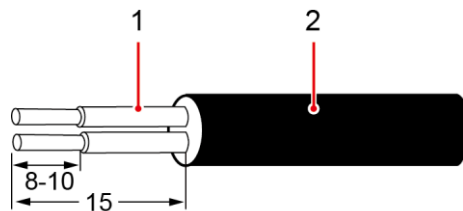

(1) Insulation layer

(2) Armored layer

Step 2 Remove the terminal block from the COM port.

Figure 4-3 Removing the terminal block

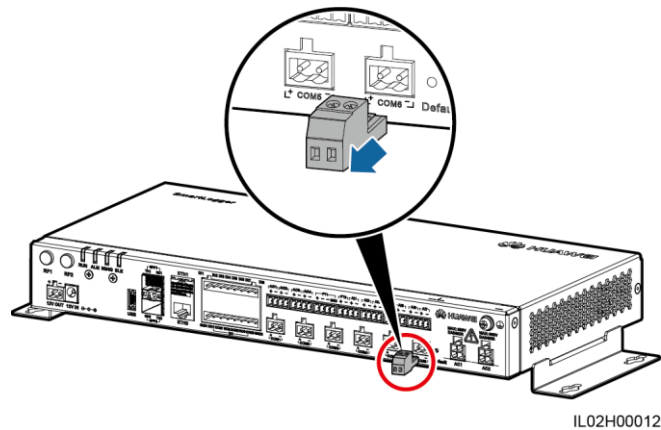

NOTE

Use a flat-head screwdriver to remove the terminal block.

Step 3 Connect cables to the terminal block and secure the cables.

Figure 4-4 Connecting cables

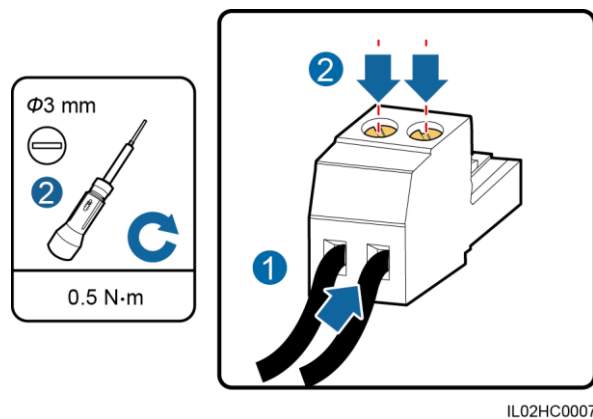

Step 4 Insert the terminal block into the COM port.

----End

4.4 Connecting a PE Cable to the SmartLogger

Prerequisites

The PE cable and OT terminal are available.

- Recommended PE cable: an outdoor copper-core cable with a cross sectional area of 4–6 mm² or 12–10 AWG
- OT terminal: M6

Procedure

Step 1 Prepare an OT terminal by following the instructions in [4.2 Preparing an OT Terminal](#).

Step 2 Secure the PE cable using the ground screw.

Figure 4-5 Connecting the PE cable

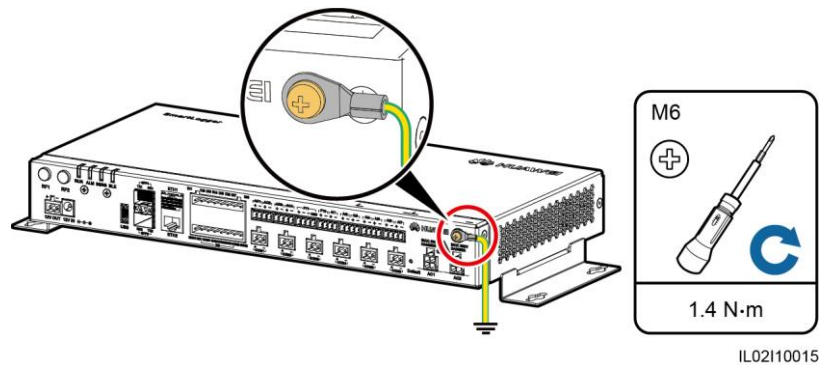

----End

4.5 Connecting the SUN2000

4.5.1 Connection Description

The SmartLogger can be connected to the SUN2000 through an RS485 communications cable or AC power cable. Communication modes for the SUN2000 with MBUS (PLC) and those without MBUS (PLC) are different. Select an appropriate communication mode based on the actual situation.

For models with the MBUS (PLC) function, you can select either the MBUS (PLC) or RS485 communications mode. For models without the MBUS (PLC) function, you can select only the RS485 communications mode.

NOTE

For the 1000 V SUN2000, the RS485 and MBUS (PLC) communication modes are mutually exclusive.

- If the RS485 communications mode is selected, do not connect an AC power cable to the MBUS (PLC) power input port of the SmartLogger.
- If MBUS (PLC) is used, do not connect an RS485 communications cable.

4.5.2 Connecting the SUN2000 over RS485

Context

NOTE

This section only describes the ports that require cable connection.

The SmartLogger provides six COM ports for RS485 communication, as shown in [Figure 4-6](#).

Figure 4-6 COM ports of the SmartLogger

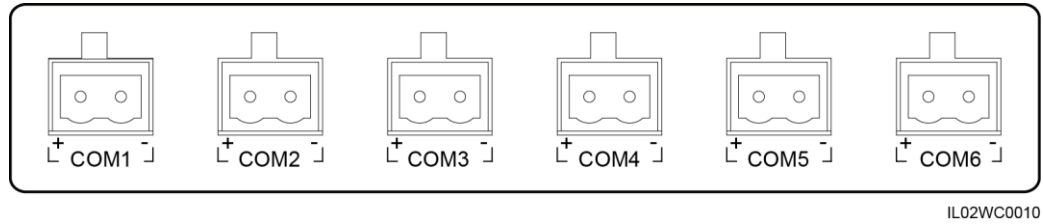

Table 4-1 COM port description

Port	Identifier	Function
COM1	+	RS485A, RS485 differential signal+
	-	RS485B, RS485 differential signal-
COM2	+	RS485A, RS485 differential signal+
	-	RS485B, RS485 differential signal-
COM3	+	RS485A, RS485 differential signal+
	-	RS485B, RS485 differential signal-
COM4	+	RS485A, RS485 differential signal+
	-	RS485B, RS485 differential signal-
COM5	+	RS485A, RS485 differential signal+
	-	RS485B, RS485 differential signal-
COM6	+	RS485A, RS485 differential signal+
	-	RS485B, RS485 differential signal-

The RS485 terminal block or RJ45 port on the SUN2000 is used for RS485 communication. There are two types of RS485 terminal blocks (1 and 2) located in different models of SUN2000s. All the SUN2000s have RJ45 ports.

- Terminal block connection
 - **Terminal block 1**
 Figure 4-7 shows the position of the terminal block in the SUN2000-50KTL/50KTL-C1. Table 4-2 describes the functions of the terminal block.

Figure 4-7 Position of the terminal block in the SUN2000

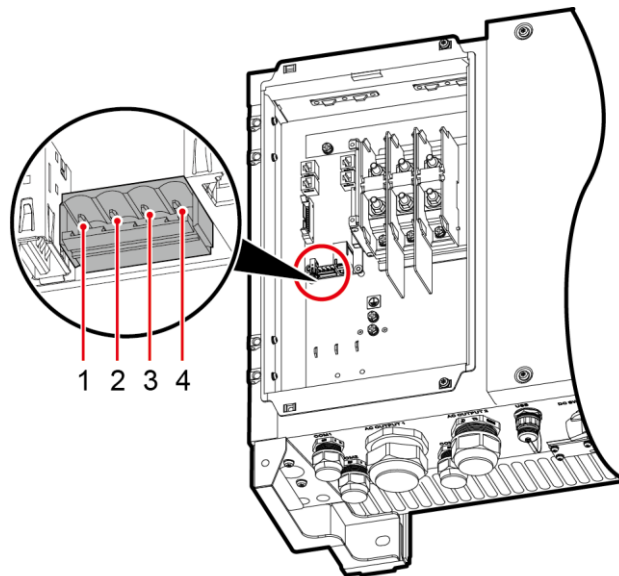

IS03W00003

Table 4-2 Functions of the RS485 terminal block

No.	Port Definition	Function
1	RS485A IN	RS485A, RS485 differential signal+
2	RS485A OUT	RS485A, RS485 differential signal+
3	RS485B IN	RS485B, RS485 differential signal-
4	RS485B OUT	RS485B, RS485 differential signal-

– **Terminal block 2**

[Figure 4-8](#) shows the position of the terminal block in the SUN2000-33KTL/40KTL. [Table 4-3](#) describes the functions of the terminal block.

Figure 4-8 Position of the terminal block in the SUN2000-33KTL/40KTL

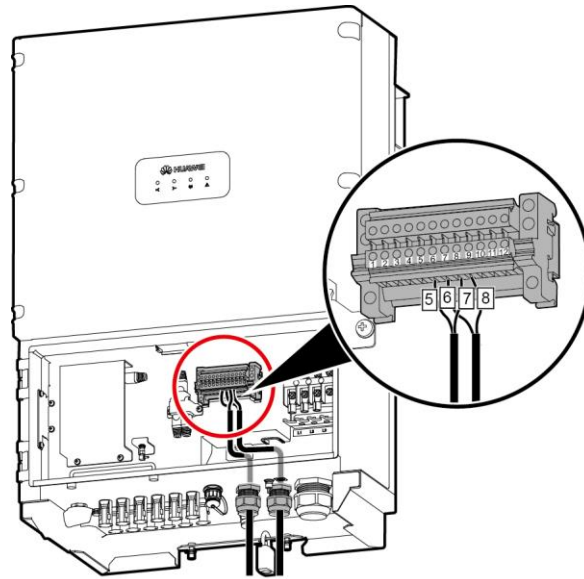

IS011C0025

Figure 4-9 Terminal block

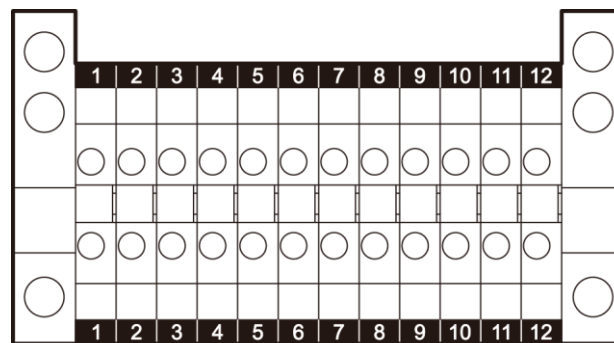

IU012C0001

Table 4-3 Functions of the RS485 terminal block

No.	Function	No.	Function
5	RS485A (IN), RS485 differential signal+	6	RS485A (OUT), RS485 differential signal+
7	RS485B (IN), RS485 differential signal-	8	RS485B (OUT), RS485 differential signal-

- RJ45 port connection
The RJ45 port needs to be connected using an RJ45 connector, as shown in [Figure 4-10](#).

Figure 4-10 RS485 RJ45 connector of the SUN2000 (side view without the fastener)

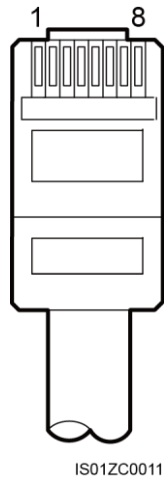

Table 4-4 Shielded network cable description

No.	Color	Function
1	White-and-orange	RS485A, RS485 differential signal+
2	Orange	RS485B, RS485 differential signal-
3	White-and-green	N/A
4	Blue	RS485A, RS485 differential signal+
5	White-and-blue	RS485B, RS485 differential signal-
6	Green	N/A
7	White-and-brown	N/A
8	Brown	N/A

NOTE

This section uses connecting the SUN2000-50KTL/50KTL-C1 through the terminal block as an example to describe the operation procedure.

Figure 4-11 shows the connection between the SmartLogger and the SUN2000 over an RS485 communications cable.

Figure 4-11 Connecting the SmartLogger to the SUN2000

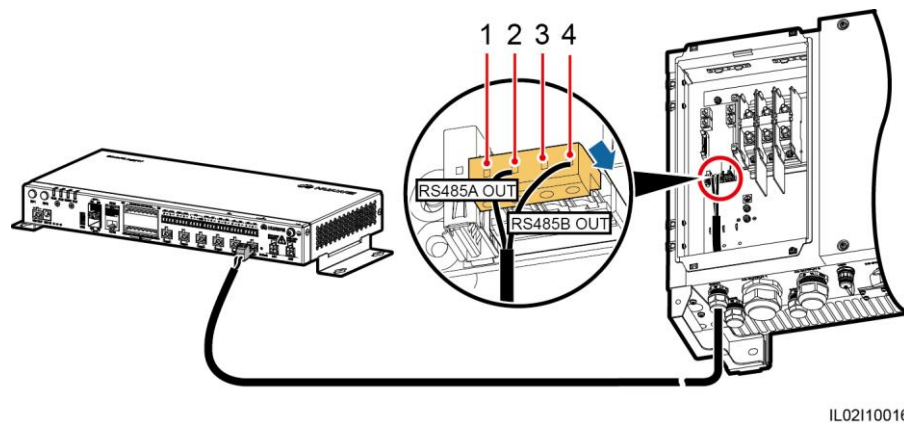

IL02110016

(1) RS485A IN (2) RS485A OUT (3) RS485B IN (4) RS485B OUT

Procedure

- Step 1** Prepare a cable with an appropriate length, strip a proper part of the insulation layer from one end, and connect the end to the SUN2000 terminal block.
- You are advised to use a DJYP2VP2-22 2x2x1 PC cable or a communications cable with a conductor cross-sectional area of 1 mm² and a cable outer diameter of 14–18 mm.
 - For details about how to strip and connect the cable, see the SUN2000 user manual.
- Step 2** Connect the other end of the cable to the COM port of the SmartLogger. For details, see [4.3 Connecting Cables to the Terminal Block on the COM Port](#).

NOTICE

- The RS485 IN and RS485 OUT ports on the SUN2000 can both connect to the SmartLogger. This document uses the RS485 OUT port as an example to describe the connection between the SUN2000 and the SmartLogger.
- When connecting the cable, ensure that the RS485A (OUT) port and RS485B (OUT) port on the SUN2000 respectively connect to the COM+ port and COM– port on the SmartLogger.

- Step 3** The **Baud Rate** settings for the SUN2000 and SmartLogger must be the same.
- For details about the communications parameter settings for the SmartLogger, see [7.11.2.2 Setting RS485 Parameters](#) or the *SUN2000 App User Manual*.
 - For details about the communications parameter settings for the SUN2000, see the *SUN2000 APP User Manual*.

----End

Follow-up Procedure

Disconnection can be performed in reverse order.

4.5.3 Connecting the SUN2000 Through AC Power Cables

Procedure

- Step 1** Connect one end of the delivered AC power cables to an MCB.
- Step 2** Connect the other end of the cable to the AC1 and AC2 ports on the SmartLogger respectively.

Figure 4-12 Connecting AC power cables to the SmartLogger

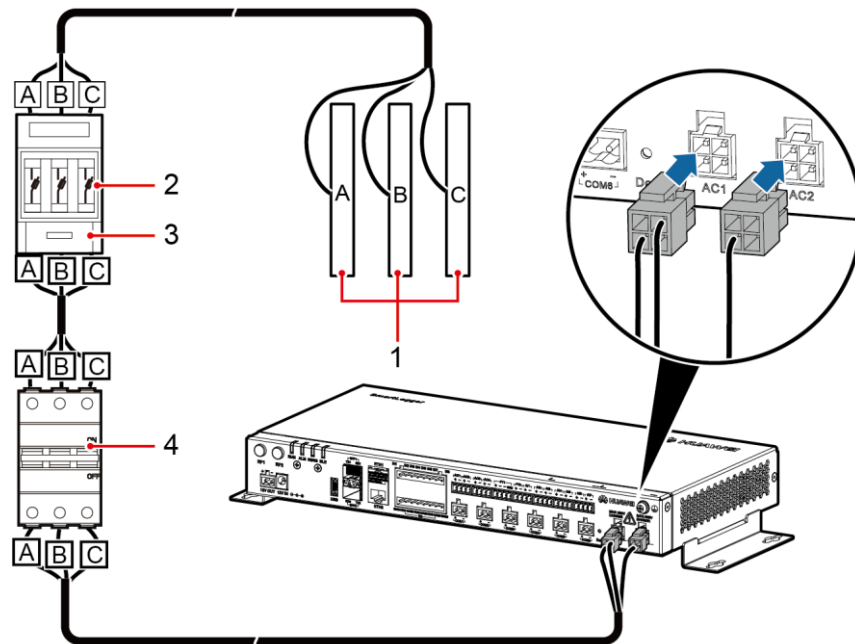

IL02I20001

Table 4-5 describes the components shown in Figure 4-12.

Table 4-5 Components

No.	Component	Specifications	Quantity
1	Busbar A/B/C	N/A	1
2	Fuse	<ul style="list-style-type: none"> When the rated AC voltage on the low-voltage side of the box-type transformer is less than or equal to 500 V, the rated voltage should be greater than or equal to 500 V; when the rated AC voltage on the low-voltage side of the box-type transformer is greater than 500 V and less than or equal to 800 V, the rated voltage should be greater than or equal to 800 V When the rated AC voltage on the 	3

No.	Component	Specifications	Quantity
		<p>low-voltage side of the box-type transformer is less than or equal to 500 V, the rated current should be greater than or equal to 6 A; when the rated AC voltage on the low-voltage side of the box-type transformer is greater than 500 V and less than or equal to 800 V, the rated current should be greater than or equal to 32 A</p>	
3	Knife fuse switch box	<ul style="list-style-type: none"> • When the rated AC voltage on the low-voltage side of the box-type transformer is less than or equal to 500 V, the rated voltage should be greater than or equal to 500 V; when the rated AC voltage on the low-voltage side of the box-type transformer is greater than 500 V and less than or equal to 800 V, the rated voltage should be greater than or equal to 800 V • When the rated AC voltage on the low-voltage side of the box-type transformer is less than or equal to 500 V, the rated current should be greater than or equal to 6 A; when the rated AC voltage on the low-voltage side of the box-type transformer is greater than 500 V and less than or equal to 800 V, the rated current should be greater than or equal to 32 A; number of poles: 3 	1
4	MCB	<ul style="list-style-type: none"> • When the rated AC voltage on the low-voltage side of the box-type transformer is less than or equal to 500 V, the rated voltage should be greater than or equal to 500 V; when the rated AC voltage on the low-voltage side of the box-type transformer is greater than 500 V and less than or equal to 800 V, the rated voltage should be greater than or equal to 800 V • When the rated AC voltage on the low-voltage side of the box-type transformer is less than or equal to 500 V, the rated current is greater than or equal to 6 A and less than or equal to 32 A; when the rated AC voltage on the low-voltage side of the box-type transformer is greater than 	1

No.	Component	Specifications	Quantity
		500 V and less than or equal to 800 V, the rated current is 32 A	

NOTE

- If the SmartLogger communicates with the SUN2000 through MBUS (PLC), no RS485 communications cable needs to be connected between them.
- After connecting cables to the AC ports, log in to the embedded WebUI and enable the MBUS function in the SmartLogger. For details, see [7.12.8.1 Connecting Devices](#). [7.9.3.3 Networking Settings](#) describes how to configure MBUS parameters for the SmartLogger.
- The port used for MBUS (PLC) networking is RS485-0. The recommended **Baud Rate** for the port is **115200 bps**, which can provide optimal communications performance.

----End

Follow-up Procedure

Disconnection can be performed in reverse order.

4.5.4 Connecting Multiple SUN2000s

The SmartLogger can connect to multiple SUN2000s through a daisy chain or AC power cables.

Daisy Chain Connection

In the daisy chain connection mode, the RS485OUT of one SUN2000 is connected to the RS485IN port of the next SUN2000, and the first SUN2000 is connected to the SmartLogger as described in [4.5.2 Connecting the SUN2000 over RS485](#).

Figure 4-13 Connecting the SmartLogger to multiple SUN2000s

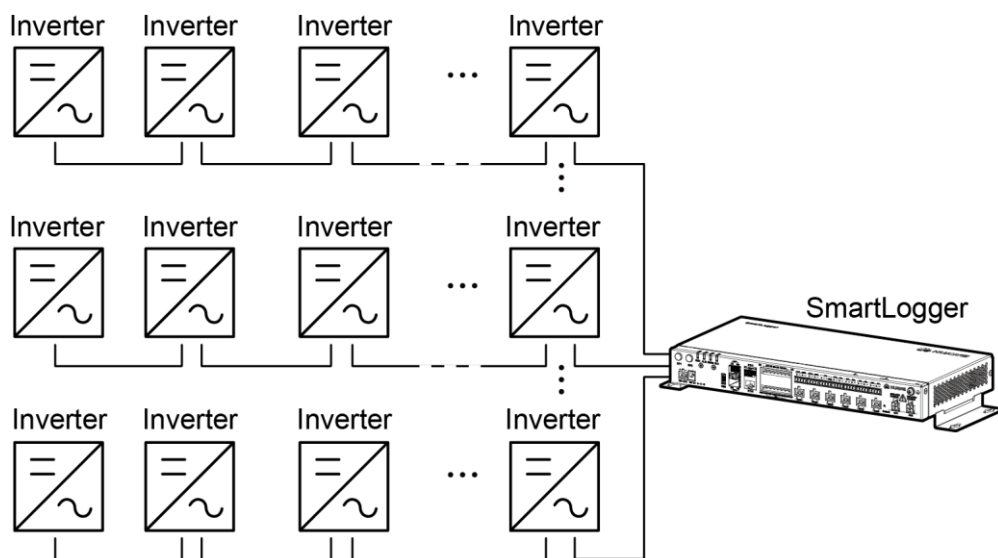

IL02140001

NOTE

- A maximum of 200 devices can connect to a single SmartLogger. You are advised to connect fewer than 30 devices to each RS485 route.
- The IP addresses for all devices in the daisy chain should be within the searching segment set in the SmartLogger and they must differ from each other. Otherwise, the communication would fail between the devices and the SmartLogger.
- You can perform the **Auto Assign Address** operation on the built-in WebUI of the SmartLogger. If an RS485 address conflict is detected for SUN2000s, the SmartLogger automatically reassigns addresses without the need for local address upgrade for the SUN2000s.
- The values of **Baud rate** for all the devices in each daisy chain should stay consistent with the baud rate of the SmartLogger.

AC Power Cable Connection

Figure 4-14 shows the method for connecting the SmartLogger2000-10/10-B/10-C to multiple SUN2000s over an AC power cable.

Figure 4-14 MBUS (PLC) networking

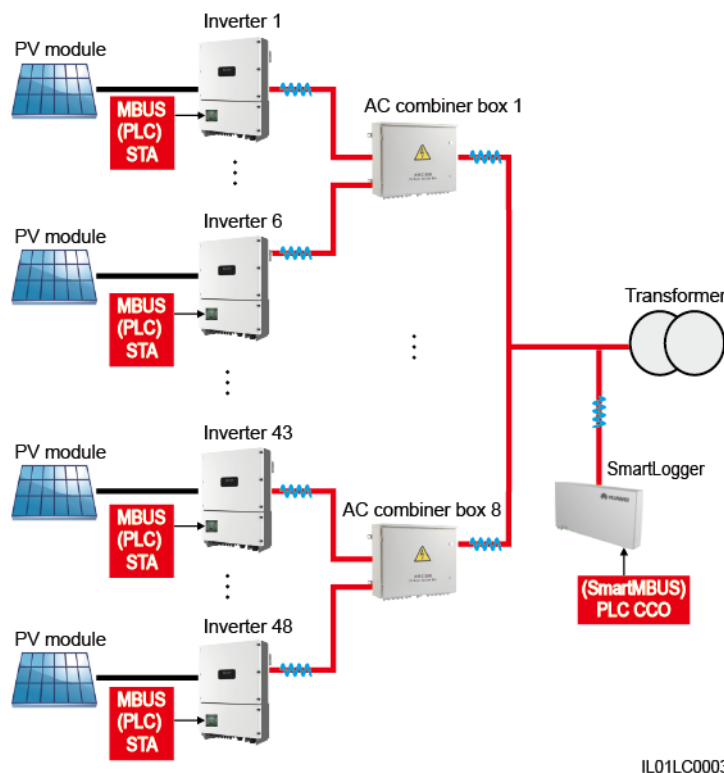

NOTE

- If the SmartLogger communicates with the SUN2000 over MBUS (PLC), ensure that the SUN2000 with MBUS (PLC) is used.
- If the SmartLogger2000-10-C communicates with the SUN2000 over MBUS (PLC), one SmartLogger2000-10-C can connect to a maximum of 80 SUN2000s over the built-in SmartMBUS (PLC CCO). If the SmartLogger2000-10-C also connects to an external SmartMBUS (PLC CCO) over the COM port, one SmartLogger2000-10-C can connect to a maximum of 150 SUN2000s.

4.6 Connecting an EMI

4.6.1 Connection Description

There are two types of EMIs. One is a standard EMI that supports Modbus-RTU, and the other is a split-type EMI that consists of various sensors.

The SmartLogger connects to a standard EMI that supports Modbus-RTU or a split-type EMI over a COM port and connects to a current- or voltage-type sensor over an AI port. The SmartLogger2000-10-C/11-C connects to a PT100/PT1000 temperature sensor over a PT port. The connection mode depends on site requirements.

NOTE

The recommended connection methods are as follows:

- Connect over a COM port if a COM or AI port is to be connected.
- Connect a current-type AI port if an AI port is to be connected.
- SmartLogger2000-10: Cannot connect to a split EMI over an AI port. Other models of SmartLoggers: Can connect to a split EMI over an AI port.
- SmartLogger2000-10: One SmartLogger can manage only one EMI or a group of EMIs. Other models of SmartLoggers: One SmartLogger can manage multiple EMIs or multiple groups of EMIs.

4.6.2 Connecting the SmartLogger to an EMI That Supports Standard Modbus-RTU

Context

Devices from different vendors may support different protocol specifications. To normally obtain information from the connected EMI, correctly configure the protocol specifications on the WebUI of the SmartLogger based on the protocol specifications delivered by the vendor.

For the definition of the RS485 communications cable for the EMI, see the delivered operation guide.

The SmartLogger provides six RS485 communications ports. For the port descriptions, see [4.5.2 Connecting the SUN2000 over RS485](#).

[Figure 4-15](#) shows how to connect the SmartLogger to an EMI over an RS485 communications cable.

Figure 4-15 Connecting the SmartLogger to an EMI

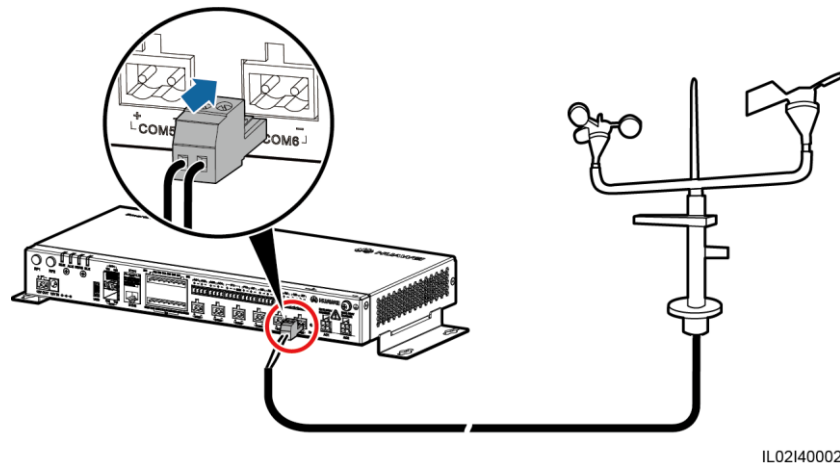

Procedure

- Step 1** Connect one end of the cable delivered with the EMI to the RS485 port of the EMI.
- Step 2** Connect the other end of the cable to the COM port of the SmartLogger. For details, see [4.3 Connecting Cables to the Terminal Block on the COM Port](#).

NOTICE

When connecting cables, ensure that the RS485+ and RS485- ports on the EMI respectively connect to the COM+ and COM- ports on the SmartLogger.

NOTE

- The EMI cannot be automatically identified. After connecting cables, log in to the embedded WebUI and manually add the EMI. For details, see [7.12.8.1 Connecting Devices](#). Set **Device Type** to **EMI** and **Connection mode** to **Modbus-RTU**.
- After adding the EMI, set parameters by following the instructions in [7.9.4.2 Setting Modbus-RTU EMI Parameters](#). Select the EMI model that is provided by the manufacturer.
- If the SmartLogger needs to be connected to an EMI and multiple inverters, connect the EMI at the end of the daisy chain, and verify that the port connected to the EMI has a unique communications address. For the daisy chain connection, see [Daisy Chain Connection](#) in [4.5.4 Connecting Multiple SUN2000s](#).

----End

Follow-up Procedure

Disconnection can be performed in reverse order.

4.6.3 Connecting the SmartLogger to a Split EMI

Connecting to an EMI over a COM Port

The EMI used in Europe and Southeast Asia is composed of sensors, whose signals need to be converted into RS485 signals (Modbus-RTU) over an extra analog-to-digital converter before the sensors are connected to the SmartLogger.

The analog-to-digital converter should provide an RS485 port and support standard Modbus-RTU. This section describes the connection between the SmartLogger and a split EMI through the ADAM4117 that functions as an analog-to-digital converter.

The SmartLogger provides six RS485 communications ports. For the port descriptions, see [4.5.2 Connecting the SUN2000 over RS485](#).

[Figure 4-16](#) shows how to connect the SmartLogger to a split EMI over an analog-to-digital converter.

Figure 4-16 Connecting the SmartLogger to a split EMI (1)

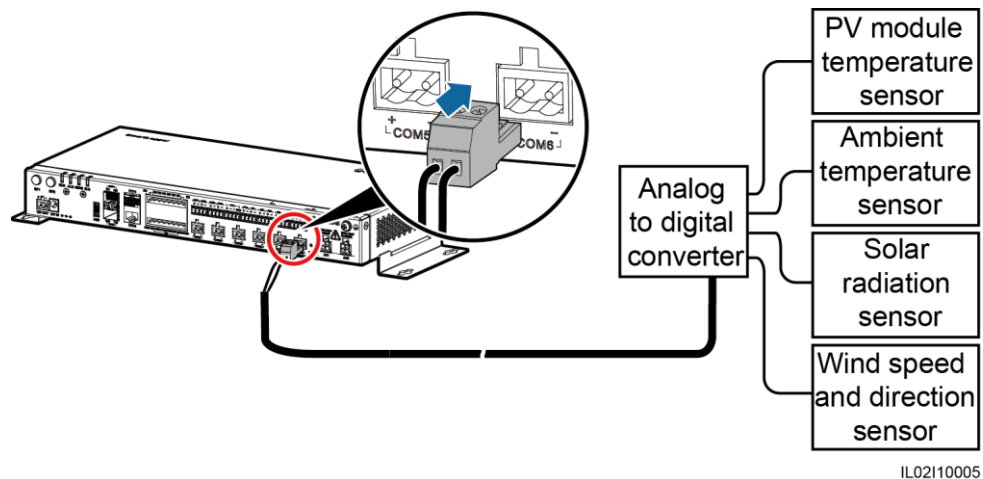

- Step 1** Prepare a cable with an appropriate length, strip a proper part of the insulation layer from one end, and connect the end to the port on the analog-to-digital converter.
- The DJYP2VP2-22 2x2x1 computer cable or a communications cable with a conductor cross-sectional area of 1 mm² and outer diameter of 14–18 mm is recommended.
 - For detailed operations, see the document delivered with the analog-to-digital converter.
- Step 2** Connect the other end of the cable to the COM port of the SmartLogger. For details, see [4.3 Connecting Cables to the Terminal Block on the COM Port](#).

NOTICE

When connecting cables, ensure that the RS485+ and RS485– ports on the analog-to-digital converter respectively connect to the COM+ and COM– ports on the SmartLogger.

- Step 3** The **Baud Rate** settings for the analog-to-digital converter and SmartLogger must be the same.

- For SmartLogger communication parameter settings, see [7.11.2.2 Setting RS485 Parameters](#) or the *SUN2000 APP User Manual*.
- For details about the communications parameter configurations for the analog-to-digital converter, see the delivered document.

Step 4 Connect each sensor to the analog-to-digital converter. For detailed operations, see the documents delivered with the analog-to-digital converter or sensors.

NOTE

- The EMI cannot be automatically identified. After connecting cables, log in to the embedded WebUI and manually add the EMI. For details, see [7.12.8.1 Connecting Devices](#). Set **Device Type** to EMI and **Connection mode** to **Modbus-RTU**.
- After adding an EMI, set its parameters. For details, see [7.9.4.2 Setting Modbus-RTU EMI Parameters](#). The EMI model is **Sensor(ADAM)**.
- If the SmartLogger needs to be connected to an EMI and multiple inverters, connect the EMI at the end of the daisy chain, and verify that the port connected to the EMI has a unique communications address. For the daisy chain connection, see [Daisy Chain Connection](#) in [4.5.4 Connecting Multiple SUN2000s](#).

----End

Connecting to an EMI over an AI Port

The EMI used in Europe and Southeast Asia is composed of sensors that need to connect to the AI ports on the SmartLogger.

[Bottom of the Shell](#) describes the AI port on the SmartLogger. [Figure 4-17](#) shows how to connect the SmartLogger to a split EMI over an AI port.

Figure 4-17 Connecting the SmartLogger to a split EMI (2)

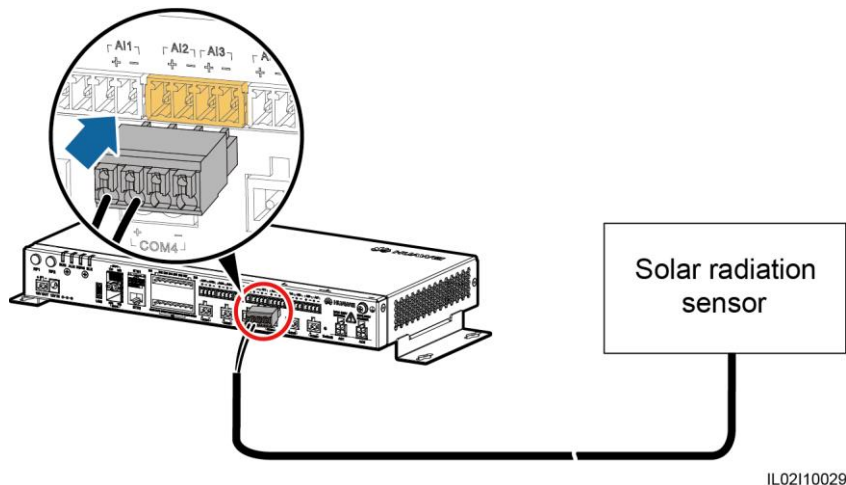

NOTE

- One sensor connects to one AI port. [Figure 4-17](#) shows only the connection between the solar radiation sensor and the SmartLogger. Connections between other sensors and the SmartLogger are the same.
- For details about the cables and cable connection operations, see the documents delivered with the sensors. The AI port on the SmartLogger is marked + and -. Connect cables correctly according to the silk screens.

- The EMI cannot be automatically identified. After connecting cables, log in to the embedded WebUI and manually add the EMI. For details, see [7.12.8.1 Connecting Devices](#). Set **Device Type** to **EMI** and **Connection mode** to **AI**.
- After adding an EMI, set its parameters. For details, see [7.9.4.3 Setting AI EMI Parameters](#).

Connecting to a PT100/PT1000 Temperature Sensor over the PT Port

NOTE

- The SmartLogger2000-10-C/11-C provides two PT ports. The PT1 port can connect to a three-wire or two-wire temperature sensor, whereas the PT2 port can connect to only a two-wire PT100/PT1000 temperature sensor (PT100/PT1000 for short).
- If the AI port has been connected to a temperature sensor, the PT port can be reserved.
- If the PT1 port connects to a two-wire PT100/PT1000, you need to short-circuit the GND port to one – port using the delivered short-circuit cable.
- For details about the cables and cable connection operations, see the documents delivered with the PT100/PT1000. The PT port on the SmartLogger is marked + and –. Connect cables correctly according to the silk screens.

The PT1 port is used as an example. [Figure 4-18](#) and [Figure 4-19](#) show how to connect the SmartLogger to the PT100/PT1000.

Figure 4-18 Connecting to a three-wire PT100/PT1000

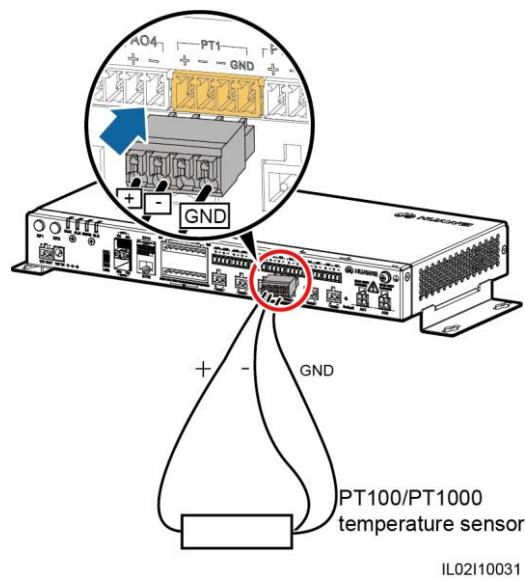
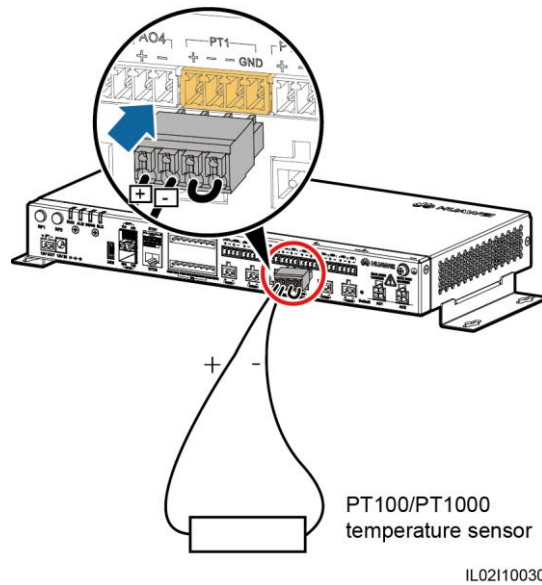

Figure 4-19 Connecting to a two-wire PT100/PT1000



NOTE

- The EMI cannot be automatically identified. After connecting cables, log in to the embedded WebUI and manually add the EMI. For details, see [7.12.8.1 Connecting Devices](#). Set **Device Type** to **EMI** and **Connection mode** to **AI**.
- After adding an EMI, set its parameters. For details, see [7.9.4.3 Setting AI EMI Parameters](#).

4.7 Connecting a Power Meter

Context

The SmartLogger can be connected to a power meter that supports the standard Modbus-RTU or DL/T645 protocol.

NOTE

- The SmartLogger can be connected to and manage only one power meter that supports the Modbus-RTU protocol.
- The SmartLogger can be connected to and manage multiple power meters that support the DL/T645 protocol.

Devices from different vendors may support different protocol specifications. To obtain information from the connected power meter, correctly configure the protocol specifications on the WebUI of the SmartLogger based on the protocol specifications delivered by the vendor.

For the definition of the RS485 communications cable for the power meter, see the delivered operation guide.

The SmartLogger provides six RS485 communications ports. For the port descriptions, see [4.5.2 Connecting the SUN2000 over RS485](#).

[Figure 4-20](#) shows how to connect the SmartLogger to a power meter.

Figure 4-20 Connecting the SmartLogger to a power meter

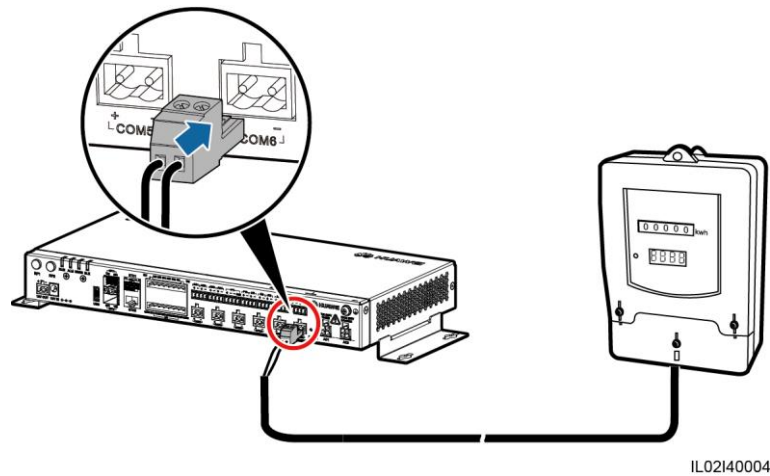

Procedure

- Step 1** Connect one end of the cable delivered with the power meter to the RS485 port of the power meter.
- Step 2** Connect the other end of the cable to the COM port of the SmartLogger. For details, see [4.3 Connecting Cables to the Terminal Block on the COM Port](#).

NOTICE

When connecting cables, ensure that the **RS485+** and **RS485-** ports on the power meter respectively connect to the **COM+** and **COM-** ports on the SmartLogger.

NOTE

- After connecting cables to the power meter that supports Modbus-RTU, log in to the embedded WebUI and set parameters for Modbus Meter. For details, see [7.11.2.3 Setting Power Meter Parameters](#).
- Devices connected to a same COM port of the SmartLogger must support the same protocol. After connecting cables, log in to the embedded WebUI and modify the COM port protocol. For details, see [7.11.2.2 Setting RS485 Parameters](#).
- A power meter cannot be detected automatically. You need to add this device manually. For details, see [7.12.8.1 Connecting Devices](#). Set **Device Type** to **Meter** and **Comm.protocol** to the protocol supported by the connected power meter.
- After modifying the protocol for a DL/T645 power meter and adding it manually, log in to the embedded WebUI to query and set parameters for DL/T645 Meter. For details, see [7.9.5 Power Meter](#).

----End

Follow-up Procedure

Disconnection can be performed in reverse order.

4.8 Connecting a Box-type Transformer

Context

The SmartLogger can be connected to a box-type transformer over the RS485 and Ethernet communication modes.

NOTE

The SmartLogger provides two Ethernet electrical ports. A box-type transformer that supports Ethernet communication can be connected to the SmartLogger through an Ethernet electrical port, and then to an NMS through the northbound interface of the SmartLogger. In this connection mode, the IP addresses of the SmartLogger and the box-type transformer must be in the same network segment.

This section describes how to connect a box-type transformer that supports the standard Modbus-RTU or standard IEC103 protocol to the SmartLogger using the RS485 communication mode.

Devices from different vendors may support different protocol specifications. To obtain information from the connected box-type transformer, correctly configure the protocol specifications on the WebUI of the SmartLogger based on the protocol specifications delivered by the vendor.

For the definition of the RS485 communications cable for the box-type transformer, see the delivered operation guide.

The SmartLogger provides six RS485 communications ports. For the port descriptions, see [4.5.2 Connecting the SUN2000 over RS485](#).

[Figure 4-21](#) shows how to connect the SmartLogger to a box-type transformer over an RS485 communications cable.

Figure 4-21 Connecting the SmartLogger to a box-type transformer

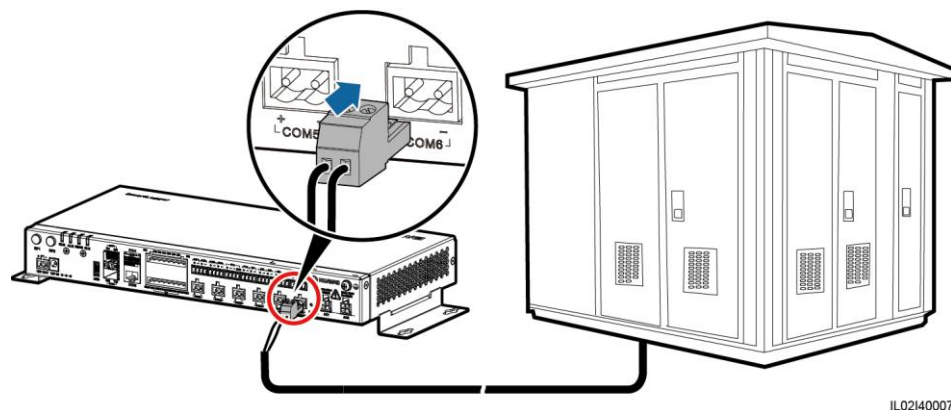

Procedure

- Step 1** Connect one end of the cable delivered with the box-type transformer to the RS485 port of the box-type transformer.
- Step 2** Connect the other end of the cable to the COM port of the SmartLogger. For details, see [4.3 Connecting Cables to the Terminal Block on the COM Port](#).

NOTICE

When connecting cables, ensure that the **RS485+** and **RS485-** ports on the box-type transformer respectively connect to the **COM+** and **COM-** ports on the SmartLogger.

NOTE

- Devices connected to a same COM port of the SmartLogger must support the same protocol.
- After connecting cables, log in to the embedded WebUI and set parameters for **Box-type Transformer**. For details, see [7.9.10 Custom Device, IEC103 Device, or IEC104 Device](#).

----End

Follow-up Procedure

Disconnection can be performed in reverse order.

4.9 Connecting a PID Module

Context

The PID module is used to prevent PV module output power degradation due to the potential induced degradation (PID) effect in a PV power system.

The SmartLogger can access a PID module that supports standard Modbus-RTU. If the model of the PID module connecting to the SmartLogger is PID01, one SmartLogger can connect to one PID module. If the model of such a PID module is SmartPID2000, one SmartLogger can connect to two PID modules.

For the definition of the RS485 communications cable for the PID module, see the delivered operation guide.

The SmartLogger provides six RS485 communications ports. For the port descriptions, see [4.5.2 Connecting the SUN2000 over RS485](#).

[Figure 4-22](#) shows how to connect the SmartLogger to the PID module.

NOTE

This section describes how to connect the SmartLogger to the PID01 module.

Figure 4-22 Connecting the SmartLogger to a PID module

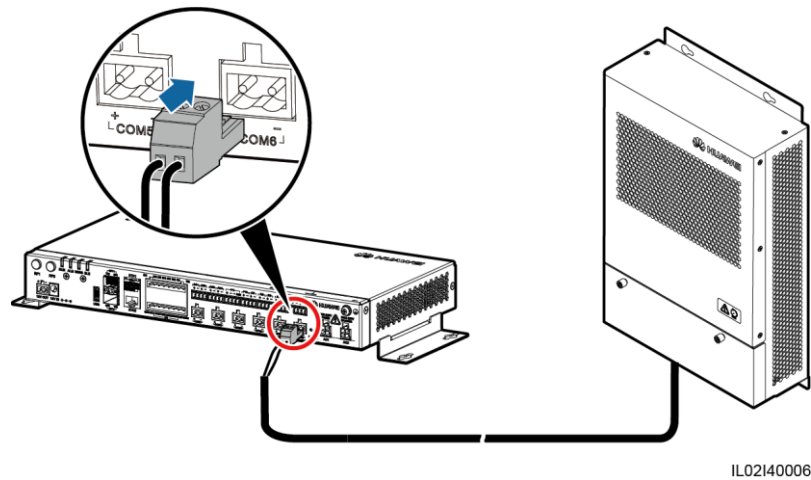

Procedure

- Step 1** Connect one end of the cable delivered with the PID module to the RS485 port of the PID module.
- Step 2** Connect the other end of the cable to the COM port of the SmartLogger. For details, see [4.3 Connecting Cables to the Terminal Block on the COM Port](#).

NOTICE

When connecting cables, ensure that the brown cable (RS485A) and black cable (RS485B) of the PID module respectively connect to the COM+ and COM- ports on the SmartLogger.

- Step 3** The **Baud rate** settings for the PID module and SmartLogger must be the same.

NOTE

- The baud rates supported by the PID module include 4800 bit/s, 9600 bit/s, 19,200 bit/s, and 115,200 bit/s.
- The PID module supports automatic address allocation. After connecting cables, log in to the embedded WebUI and search for the PID module by clicking **Auto. Search** in [7.12.8.1 Connecting Devices](#).
- For details about PID parameter settings, see [7.9.6.2 Setting Running Parameters](#) in [7.9.6 PID](#).
- The default RS485 communications address of the PID module is 1. To change the RS485 communications address, log in to the embedded WebUI and click **Auto Assign Address** in [7.12.8.1 Connecting Devices](#).

----End

Follow-up Procedure

Disconnection can be performed in reverse order.

4.10 Connecting a Ripple Control Receiver

Prerequisites

You have prepared two-core or multiple-core cables with a cross sectional area of 1.5 mm² (recommended).

Context

In Germany and some European areas, a ripple control receiver is used to convert a power grid dispatching signal to a dry contact signal. The dry contact is required for receiving the power grid dispatching signal.

Figure 4-23 DI ports of the SmartLogger

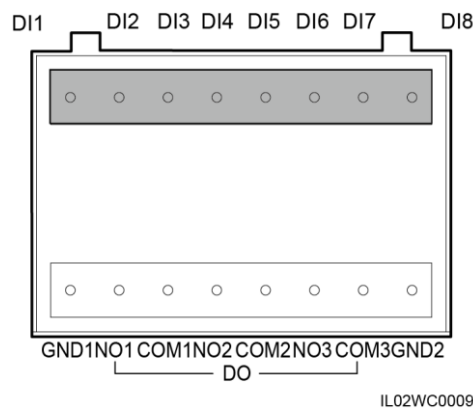

Table 4-6 DI port description

Port	Function
GND1	Dry contact input common terminal 1, used for active power derating for DI1–DI4
DI1	DI_1
DI2	DI_2
DI3	DI_3
DI4	DI_4
DI5	DI_5
DI6	DI_6
DI7	DI_7
DI8	DI_8
GND2	Dry contact input common terminal 2, used for reactive power compensation for DI5–DI8

NOTE

DI1–DI4 are used for active power derating, and DI5–DI8 are used for reactive power compensation.

Figure 4-24 shows how to connect the SmartLogger to a ripple control receiver.

Figure 4-24 Connecting a ripple control receiver

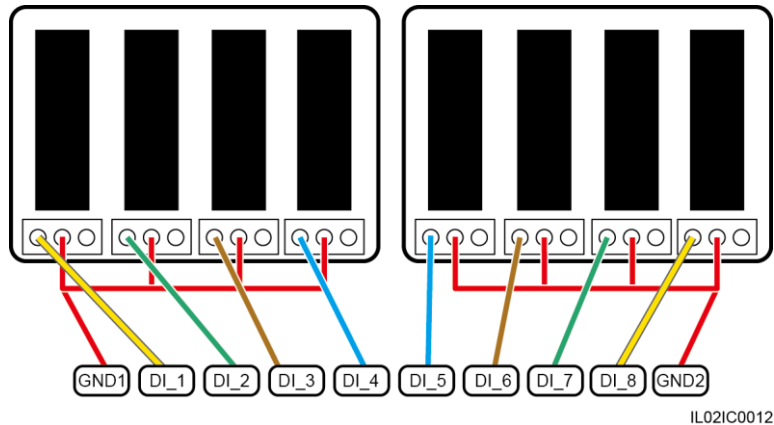

Procedure

- Step 1** Connect one end of the cable to the ripple control receiver.
- Step 2** Strip 8 mm of the insulation layer at the other end of the cable.
- Step 3** Remove the terminal block from the DI port.

Figure 4-25 Removing the terminal block

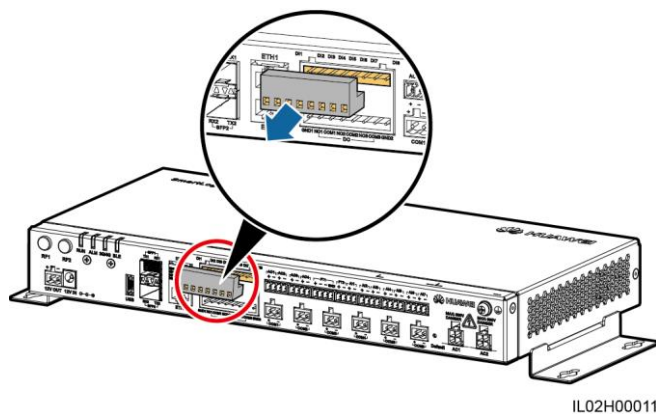

NOTE

Use a flat-head screwdriver to remove the terminal block.

- Step 4** Connect cables to the terminal block and secure the cables.

Figure 4-26 Connecting cables

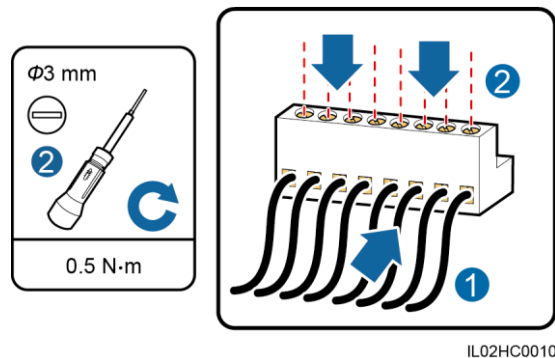

Step 5 Insert the terminal block into the DI port.

NOTICE

To ensure that the power grid scheduling function is normal, set the corresponding parameters (**Active Power Control** or **Reactive Power Control**) on the embedded WebUI after connecting cables. For details, see [8 Power Grid Scheduling](#).

----End

Follow-up Procedure

Disconnection can be performed in reverse order.

4.11 Connecting an Ethernet Network Cable

Context

- The SmartLogger provides two Ethernet electrical ports, through which the SmartLogger can connect to a third-party device.
- The SmartLogger can be connected to an Ethernet switch, router, or POE module. It can also be connected to the Ethernet electrical port of a PC directly or through a hub. Select the device to be connected based on the actual networking scenario. For details on typical scenarios, see [2.4 Typical Networking Scenarios](#).

Procedure

Step 1 Connect one end of the delivered network cable to the Ethernet electrical port of a device.

NOTE

If the delivered cable is too short, pay attention to the following when preparing a cable:

- Select a CAT 5E or higher-class shielded network cable.
- The cable length should not exceed 100 m.

Step 2 Connect the other end of the network cable to **ETH1** or **ETH2** of the SmartLogger.

Figure 4-27 Connecting an Ethernet network cable

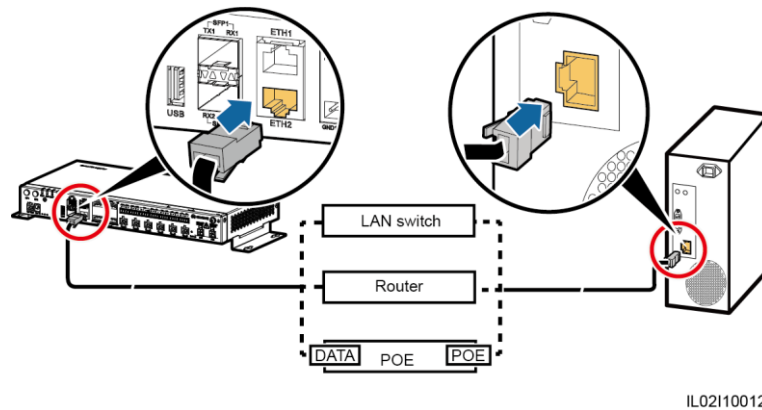

NOTE

- A POE module needs to be connected to the **DATA** port of the SmartLogger.
- The default IP address of the SmartLogger is 192.168.0.10, the default subnet mask is 255.255.255.0, and the default gateway is 192.168.0.1.
- If the SmartLogger is connected to a PC directly or through a hub, set the IP addresses of the SmartLogger and PC in the same network segment. For example, if the IP address of the SmartLogger is 192.168.0.10, set the IP address of the PC to 192.168.0.11. The subnet mask and the gateway of the PC should be consistent with those of the SmartLogger.
- If the SmartLogger is connected to a PC through a networking device (such as a router), set the IP addresses of the SmartLogger and networking device in the same network segment. Set the gateway of the SmartLogger correctly so that it can communicate with the networking device.
- To enable communication between the SmartLogger and the NetEco, set NetEco parameters properly on the SmartLogger. For details, see [7.11.2.4 Setting Management System Parameters](#).

----End

Follow-up Procedure

Disconnection can be performed in reverse order.

4.12 Connecting Fiber Jumpers

Context

The SmartLogger can be connected to devices such as an ATB through fiber jumpers. You can select the devices to be connected based on the actual networking scenario. For details on typical scenarios, see [2.4 Typical Networking Scenarios](#).

Procedure

- Step 1** Insert the optical module into **SFP1** or **SFP2** of the SmartLogger.

NOTICE

- An optical module is optional. A 100M optical module (eSFP, 1310 nm, and single mode) with transmission distance of at least 15 km is recommended.
- When inserting an optical module into the **SFP1** port, verify that the side with a handle faces upwards. When inserting an optical module into the **SFP2** port, verify that the side with a handle faces downwards.
- The optical switch used for the central control room supports RSTP and STP. To ensure the communication between the optical switch and the SmartLogger, the configured optical module must have a transmission speed of 100 Mbit/s.

Step 2 Connect the two fiber jumpers delivered with the optical module to the ports on the optical module.

Step 3 Connect the other end of the fiber jumper to the port on the ATB.

Figure 4-28 Connecting an ATB

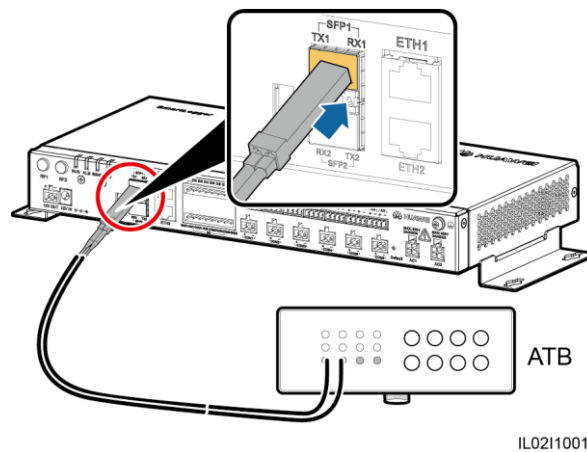

Step 4 Determine the operating status based on the Ethernet optical port indicators.

Figure 4-29 Ethernet optical port indicators

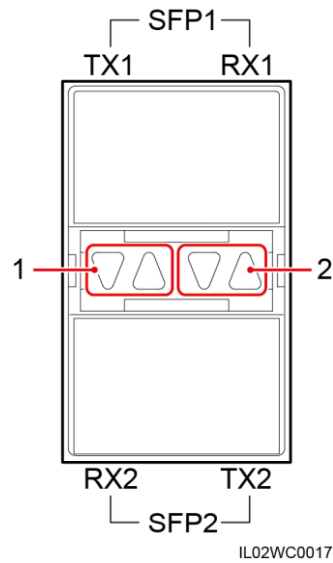

Table 4-7 Ethernet optical port indicator description

Indicator	Status	Meaning
(1) Upper port (2) Lower port	Green and yellow off	No optical module is inserted into the Ethernet optical port.
	Green steady on and blinking yellow at short intervals (0.1s on and 0.1s off)	The fiber link is being set up.
	Green steady on and yellow blinking intermittently	The data is being transmitted.
	Green steady on and blinking yellow at long intervals (0.1s on and 1.9s off)	The fiber link is normal.

----End

Follow-up Procedure

Disconnection can be performed in reverse order.

NOTE

1. When removing a fiber jumper, press down the clip first.
2. When removing an optical module, press down the handle and pull the module outwards.

5 System Operation

5.1 Checking Before Power-On

To ensure that the SmartLogger can work properly after power-on, check the items listed in [Table 5-1](#) before powering on the SmartLogger.

Table 5-1 Items to be checked for the SmartLogger before power-on

No.	Check That	Check Result
1	The SmartLogger is installed correctly and reliably.	<input type="checkbox"/> Passed <input type="checkbox"/> Failed
2	Ground cables of the SmartLogger are connected to ground points securely and reliably.	<input type="checkbox"/> Passed <input type="checkbox"/> Failed
3	The cables between the SmartLogger and other devices are connected securely and reliably.	<input type="checkbox"/> Passed <input type="checkbox"/> Failed
4	The RS485 communications cable is connected securely and reliably.	<input type="checkbox"/> Passed <input type="checkbox"/> Failed
5	The AC power cable is securely and reliably connected to the SmartLogger when the AC power cable is used for communication.	<input type="checkbox"/> Passed <input type="checkbox"/> Failed
6	Ports that are not used (such as RF1, RF2, Ethernet optical port, and Ethernet port) are protected by dustproof plugs.	<input type="checkbox"/> Passed <input type="checkbox"/> Failed
7	Routing for the power cable and signal cable meets the requirements for routing strong-current and weak-current cables and complies with the cable routing plan.	<input type="checkbox"/> Passed <input type="checkbox"/> Failed
8	Cables are bound neatly, and cable ties are secured evenly and properly in the same direction.	<input type="checkbox"/> Passed <input type="checkbox"/> Failed
9	There is no unnecessary adhesive tape or cable tie on cables.	<input type="checkbox"/> Passed <input type="checkbox"/> Failed

5.2 System Power-On

Prerequisites

You have performed the operations described in [5.1 Checking Before Power-On](#).

NOTICE

- When powering on the system, use the supplied power adapter. The power adapter model varies depending on regions. For example, in the member countries of the EU, the power adapter used in the SmartLogger2000-10/10-B/11-B is FUHUA HW-60-12AC14D, and the power adapter used in the SmartLogger2000-10-C/11-C is FUHUA HW-24-12AC14D. The rated input of the power adapter is 100–240 V AC, and 50 Hz or 60 Hz. If adapters of other models are used, the equipment may be damaged.
- Select an AC socket that matches the power adapter.

Context

In a scenario with a smart array controller, the SmartLogger is installed before delivery, and the power cable is connected.

Procedure

- Step 1** Insert the output terminal of the power adapter into the **12V IN** port of the SmartLogger.
- Step 2** Insert the power cable into the power adapter.
- Step 3** Insert the power cable plug into an AC socket.

In a scenario without a smart array controller, place the power adapter on the top of the SmartLogger and secure the power adapter using cable ties.

NOTE

The adapters and sockets vary in different regions. [Figure 5-1](#) is for reference only. The actual objects prevail.

Figure 5-1 Connecting the power cable in a scenario without a smart array controller

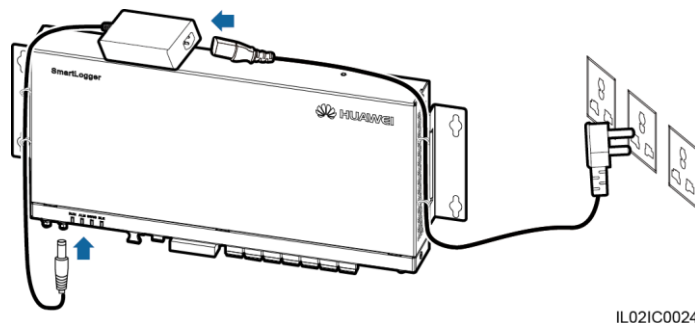

- Step 4** Switch on the circuit breaker of the AC socket.

Step 5 Switch on the upstream circuit breaker of the AC power cable.

 **NOTE**

[Step 5](#) needs to be performed in the MBUS (PLC) networking scenario.

----End

6 Man-Machine Interaction

6.1 USB Flash Drive Operation

6.1.1 Exporting Data

Context

It is recommended that you use a SanDisk, Netac, or Kingston USB flash drive to ensure compatibility.

By exporting data, you can obtain active alarms, historical alarms, performance data, exception takeover logs, commissioning logs, operation logs, fault information files, and electronic labels.

- Data from the SmartLogger2000-10/10-B/11-B can only be exported by method 1.
- Data from the SmartLogger2000-10-C/11-C can be exported by method 1 or 2. Select either method in practice.

Procedure

- Method 1
 - a. Insert the USB flash drive into the USB port at the bottom of the SmartLogger.
 - b. Log in to the app, choose **More > System Maintenance > Generate Local Maint. Script** on the main menu page, and generate a boot script file. For details, see the *SUN2000 APP User Manual*.

NOTE

The generated boot script file is automatically saved in the root directory of the USB flash drive.

- c. Remove the USB flash drive from the USB port at the bottom of the SmartLogger, and insert the USB flash drive into the port again.

NOTE

After the USB flash drive is connected again, the SmartLogger can automatically detect the boot script file.

- d. The SmartLogger automatically executes all commands specified in the boot script file. View the LED indicator to determine the operating status.

NOTICE

- Verify that the USB flash drive contains a boot script file; otherwise, the SmartLogger cannot execute the operations.
- If SmartLoggers have the same app login password, the boot script file generated by one SmartLogger can be imported to other SmartLoggers by using a USB flash drive.
- The initial app login password of the SmartLogger is **00000a**.
- Use the initial password upon first power-on and change it immediately after login. To ensure account security, change the password periodically and keep the new password in mind. Not changing the initial password may cause password disclosure. A password left unchanged for a long period of time may be stolen or cracked. If a password is lost, devices cannot be accessed. In these cases, the user is liable for any loss caused to the PV plant.

Table 6-1 LED indicator description

Indicator (Silk Screen)	Status	Meaning
ALM	Green off	No local maintenance is in progress.
	Blinking green at long intervals (1s on and 1s off)	Local maintenance is in progress.
	Green steady on	Local maintenance succeeds.
	Blinking green at short intervals (0.125s on and 0.125s off)	Local maintenance fails.

- Method 2
 - Insert the USB flash drive into the USB port at the bottom of the SmartLogger.
 - Log in to the app, choose **More > Device Logs** on the main menu, and select the device to export related data. For details, see the *SUN2000 APP User Manual*.
 - The SmartLogger automatically executes commands. The LED indicator status reflects the execution situation. For details, see the [Table 6-1](#).

----End

6.1.2 Exporting All Files

Context

It is recommended that you use a SanDisk, Netac, or Kingston USB flash drive to ensure compatibility.

 **NOTE**

- If the SmartLogger needs to be replaced, you can export all the files before the replacement and then import the files into the new SmartLogger to ensure data integrity.

- After exporting all files, you can view information about the SmartLogger and devices connecting to the SmartLogger.

Procedure

- Step 1** Insert the USB flash drive into the USB port at the bottom of the SmartLogger.
- Step 2** Log in to the app, choose **More > System Maintenance > Generate Local Maint. Script** on the main menu page, and generate a boot script file. For details, see the *SUN2000 APP User Manual*.

NOTE

The generated boot script file is automatically saved in the root directory of the USB flash drive.

- Step 3** Remove the USB flash drive from the USB port at the bottom of the SmartLogger, and insert the USB flash drive into the port again.

NOTE

After the USB flash drive is connected again, the SmartLogger can automatically detect the boot script file.

- Step 4** The SmartLogger automatically executes all commands specified in the boot script file. View the LED indicator to determine the operating status.

NOTICE

- Verify that the USB flash drive contains a boot script file; otherwise, the SmartLogger cannot execute the operations.
- If SmartLoggers have the same app login password, the boot script file generated by one SmartLogger can be imported to other SmartLoggers by using a USB flash drive.
- The initial app login password of the SmartLogger is **00000a**.
- Use the initial password upon first power-on and change it immediately after login. To ensure account security, change the password periodically and keep the new password in mind. Not changing the initial password may cause password disclosure. A password left unchanged for a long period of time may be stolen or cracked. If a password is lost, devices cannot be accessed. In these cases, the user is liable for any loss caused to the PV plant.

Table 6-2 LED indicator description

Indicator (Silk Screen)	Status	Meaning
ALM	Green off	No local maintenance is in progress.
	Blinking green at long intervals (1s on and 1s off)	Local maintenance is in progress.
	Green steady on	Local maintenance succeeds.
	Blinking green at short intervals (0.125s on and	Local maintenance fails.

Indicator (Silk Screen)	Status	Meaning
	0.125s off)	

----End

6.1.3 Importing All Files

Prerequisites

A USB flash drive contains a boot script file and all exported files.

Context

It is recommended that you use a SanDisk, Netac, or Kingston USB flash drive to ensure compatibility.

Procedure

- Step 1** Insert the USB flash drive into the USB port at the bottom of the SmartLogger.
- Step 2** Log in to the app, choose **More > System Maintenance > Generate Local Maint. Script** on the main menu page, and generate a boot script file. For details, see the *SUN2000 APP User Manual*.

NOTE

The generated boot script file will replace the script file generated when all files are exported in the USB flash drive.

- Step 3** The SmartLogger automatically executes all commands specified in the boot script file. View the LED indicator to determine the operating status.

NOTICE

- Verify that the USB flash drive contains a boot script file; otherwise, the SmartLogger cannot execute the operations.
- A boot script file generated in a SmartLogger can be imported into other SmartLoggers. Ensure that app login password of a SmartLogger to which files are imported is consistent with that of the SmartLogger which generates the boot script file. If the app login passwords are inconsistent, you need to generate a new boot script file in the SmartLogger to which files are imported.
- The initial app login password of the SmartLogger is **00000a**.
- Use the initial password upon first power-on and change it immediately after login. To ensure account security, change the password periodically and keep the new password in mind. Not changing the initial password may cause password disclosure. A password left unchanged for a long period of time may be stolen or cracked. If a password is lost, devices cannot be accessed. In these cases, the user is liable for any loss caused to the PV plant.

Table 6-3 LED indicator description

Indicator (Silk Screen)	Status	Meaning
ALM	Green off	No local maintenance is in progress.
	Blinking green at long intervals (1s on and 1s off)	Local maintenance is in progress.
	Green steady on	Local maintenance succeeds.
	Blinking green at short intervals (0.125s on and 0.125s off)	Local maintenance fails.

----End

6.1.4 Upgrading the Application

Context

It is recommended that you use a SanDisk, Netac, or Kingston USB flash drive to ensure compatibility.

- The SmartLogger2000-10/10-B/11-B can only be upgraded by method 1.
- The SmartLogger2000-10-C/11-C can be upgraded by method 1 or 2. Select either method in practice.

Procedure

- Method 1

- a. Log in to <http://support.huawei.com/carrier/>, browse or search for SmartLogger on the **Product Support** tab page, and download the required upgrade package on the **Software** tab page.

 **NOTE**

The upgrade package is named **smartlogger2000.zip**. Store the upgrade package in the root directory of a USB flash drive, and do not decompress it.

- b. Insert the USB flash drive into the USB port at the bottom of the SmartLogger.
- c. Log in to the app, choose **More > System Maintenance > Generate Local Maint. Script** on the main menu page, and generate a boot script file. For details, see the *SUN2000 APP User Manual*.
- d. Replace the boot script file in the upgrade package with the boot script file in the USB flash drive.

 **NOTE**

The boot script file in the upgrade package is named **logger_lmt_mgr_cmd.emap**.

- e. Insert the USB flash drive into the USB port at the bottom of the SmartLogger. The SmartLogger automatically executes all commands specified in the boot script file. View the LED indicator to determine the operating status.

Table 6-4 LED indicator description

Indicator (Silk Screen)	Status	Meaning
ALM	Green off	No local maintenance is in progress.
	Blinking green at long intervals (1s on and 1s off)	Local maintenance is in progress.
	Green steady on	Local maintenance succeeds.
	Blinking green at short intervals (0.125s on and 0.125s off)	Local maintenance fails.

- f. After upgrade is complete, the SmartLogger automatically restarts.
- Method 2
 - a. Log in to <http://support.huawei.com/carrier/>, browse or search for SmartLogger on the **Product Support** tab page, and download the required upgrade package on the **Software** tab page.

 **NOTE**

The upgrade package is named **smartlogger2000.zip**. Store the upgrade package in the root directory of a USB flash drive, and do not decompress it.

- b. Insert the USB flash drive into the USB port at the bottom of the SmartLogger.
- c. Log in to the app, choose **More > Device Update** on the main menu, and update the device. For details, see the *SUN2000 APP User Manual*.
- d. The SmartLogger automatically executes commands. The LED indicator status reflects the execution situation. For details, see the [Table 6-1](#).
- e. After upgrade is complete, the SmartLogger automatically restarts.

----End

6.1.5 Upgrading the BSP

Context

It is recommended that you use a SanDisk, Netac, or Kingston USB flash drive to ensure compatibility.

NOTICE

For details about how to upgrade the board support package (BSP), see *SmartLogger Upgrade Guide* or contact Huawei technical support.

Procedure

- Step 1** Log in to <http://support.huawei.com/carrier/>, browse or search for SmartLogger on the **Product Support** tab page, and download the required upgrade package on the **Software** tab page.

NOTE

The upgrade package is named **smartlogger2000_bsp.zip**. Store the upgrade package in the root directory of a USB flash drive, and do not decompress it.

- Step 2** Insert the USB flash drive into the USB port at the bottom of the SmartLogger.
- Step 3** Log in to the app, choose **More > System Maintenance > Generate Local Maint. Script** on the main menu page, and generate a boot script file. For details, see the *SUN2000 APP User Manual*.
- Step 4** Replace the boot script file in the upgrade package with the boot script file in the USB flash drive.

NOTE

The boot script file in the upgrade package is named **logger_lmt_mgr_cmd.emap**.

- Step 5** Insert the USB flash drive into the USB port at the bottom of the SmartLogger. The SmartLogger automatically executes all commands specified in the boot script file. View the LED indicator to determine the operating status.

Table 6-5 LED indicator description

Indicator (Silk Screen)	Status	Meaning
ALM	Green off	No local maintenance is in progress.
	Blinking green at long intervals (1s on and 1s off)	Local maintenance is in progress.
	Green steady on	Local maintenance succeeds.

Indicator (Silk Screen)	Status	Meaning
	Blinking green at short intervals (0.125s on and 0.125s off)	Local maintenance fails.

Step 6 After upgrade is complete, the SmartLogger automatically restarts.

----End

6.2 NMS Operation

Using the NMS, you can perform firmware upgrade and log export for the SmartLogger. For details, see *iManager NetEco 1000S User Manual*.

6.3 App Operation

Using the app, you can perform real-time monitoring, alarm query, and device management for the SmartLogger and southbound devices connecting to the SmartLogger. For details, see *SUN2000 APP User Manual*.

7 WebUI

7.1 Introduction to WebUI

NOTICE

- The web software version corresponding to the WebUI snapshots in this document is SmartLogger V200R002C20SPC119. The data on the WebUI snapshots is for reference only.
- Parameters displayed on the WebUI vary with the SmartLogger model. This document describes the operations to be performed on the WebUI for the SmartLogger2000-10-C.
- When you log in to the WebUI with different identifications, parameters displayed on the operation pages vary. This document describes the operation pages displayed after you log in as **Advanced User**.
- The parameter names, value ranges, and default values are subject to change. The actual display prevails.
- The 1000 V and 1500 V inverters have the maximum input voltages of 1000 V and 1500 V respectively. The 1100 V inverter refers to the inverter with the maximum input voltage of 1100 V or the SUN2000-33KTL-US/36KTL-US/40KTL-US. The maximum input voltage can be queried from the product nameplate or the appropriate user manual.
- Delivering a reset, shutdown, or upgrade command to the solar inverters may cause power grid connection failure, which affects the energy yield.
- Only professionals are allowed to set the grid parameters, protection parameters, feature parameters, and power adjustment parameters of the solar inverters. If the grid parameters, protection parameters and feature parameters are incorrectly set, the solar inverters may not connect to the power grid. If the power adjustment parameters are incorrectly set, the solar inverters may not connect to the power grid as required. In these cases, the energy yield will be affected.
- Only professionals are allowed to set the power grid scheduling parameters of the SmartLogger. Incorrect settings may cause the PV plant to fail to connect to the power grid as required, which affects the energy yield.

7.2 Preparations for Login

Operating Environment

The operating environment for the WebUI should meet the following requirements:

- Operating system: Windows
- Internet Explorer 8 to Internet Explorer 11, Firefox 17–Firefox 39, or CHROME 41–CHROME 45 (Windows 7)
- Minimum resolution: 1024x768

NOTE

- For Internet Explorer 8, the recommended release is 8.0.7601.17514 or later.
- For Internet Explorer 10, the compatible mode is recommended.

Setting the IP Address

Correctly set the IP address, subnet mask, and gateway for the SmartLogger, PC, and network devices (when connected).

Setting the LAN

NOTICE

- If the SmartLogger is connected to a local area network (LAN) and a proxy server has been set, you need to cancel the proxy server settings.
- If the SmartLogger is connected to the Internet and the PC is connected to the LAN, do not cancel the proxy server settings.

Step 1 Open Internet Explorer.

Step 2 Choose **Tools > Internet Options**.

Step 3 Click the **Connections** tab and then click **LAN settings**.

Figure 7-1 LAN setting (1)

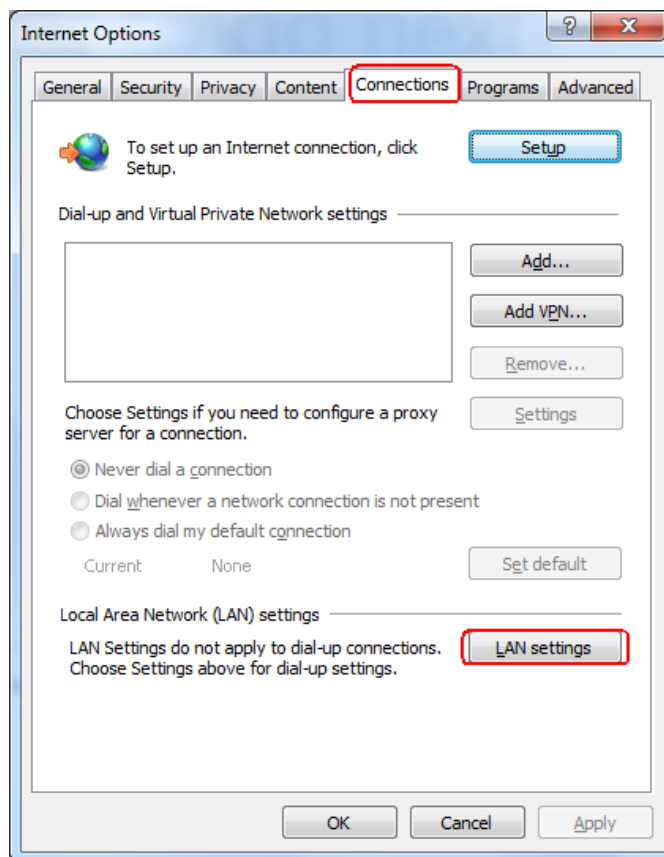

Step 4 Deselect **User a proxy server for your LAN**.

Figure 7-2 LAN setting (2)

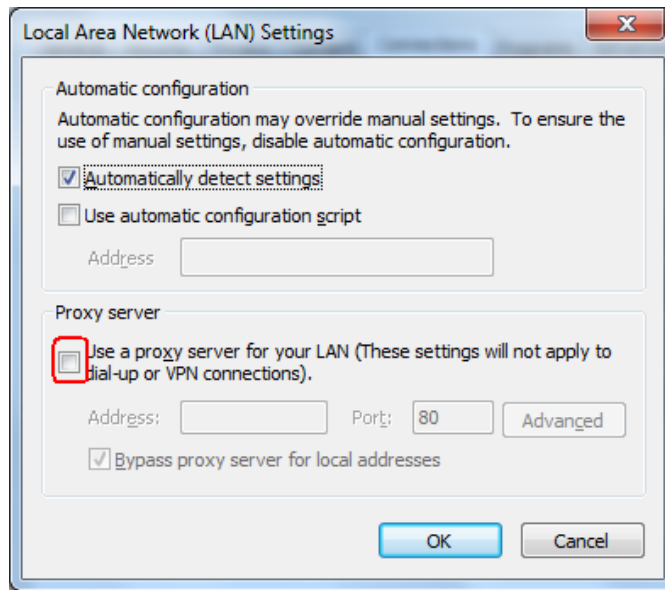

Step 5 Click **OK**.

----End

Setting Internet Explorer Security

NOTICE

To export fault information and operation logs, you need to set the Internet Explorer security.

Step 1 Open Internet Explorer.

Step 2 Choose **Tools > Internet Options**.

Step 3 Click the **Security** tab and then click **Sites** in **Trusted sites**.

Figure 7-3 Internet Explorer security setting (1)

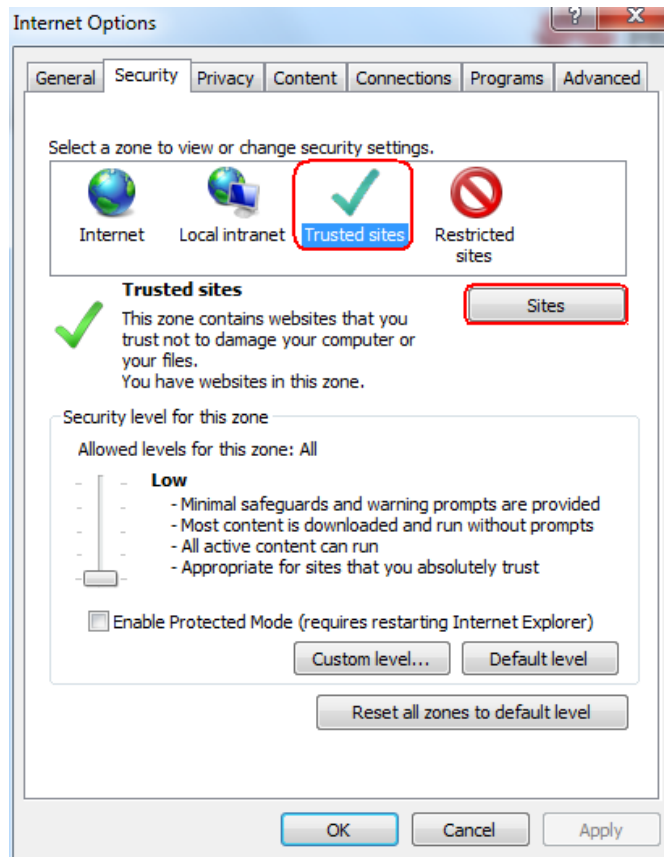

Step 4 Enter the website address of the WebUI (enter the default IP address 192.168.0.10 of the SmartLogger for the first login), click **Add**, and then click **Close**.

Figure 7-4 Internet Explorer security setting (2)

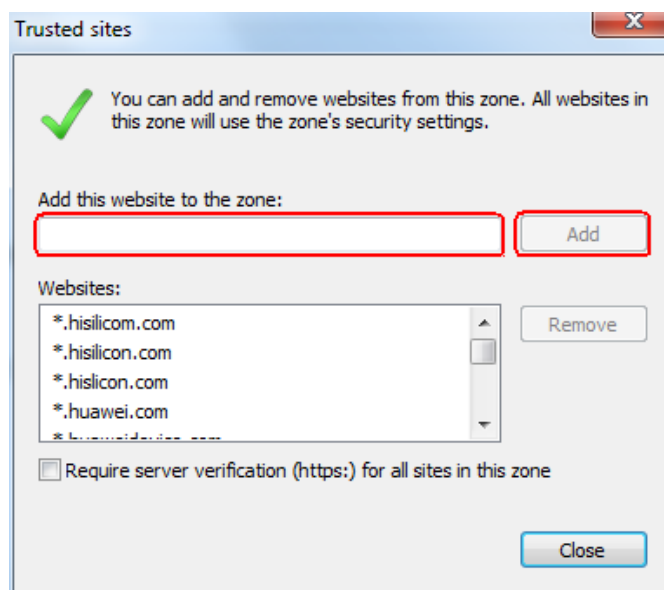

Step 5 Set **Security level for this zone** to **Medium** or **Low**.

----End

7.3 Logging In to the WebUI

Context

The SmartLogger has been connected to a PC directly or over the Ethernet. For details, see [4.11 Connecting an Ethernet Network Cable](#).

NOTE

The IP address of the SmartLogger can be obtained as follows:

- When logging in to the app for the first time, obtain information including **IP address** from **Ethernet** under **Quick Settings**.
- When logging in to the APP subsequently, choose **Settings** > **Comm. Param** > **Ethernet** to view the information.
- To restore the IP address to the default IP address, press and hold down the Default key for more than 10s until the RUN indicator blinks at short intervals (0.125s on and 0.125s off) and all other indicators are off, and then release the Default key. The operation is valid within 5 minutes.

If you log in to the WebUI for the first time, a security risk warning shown in [Figure 7-5](#) displayed. Click **Continue to this website**. to continue the WebUI login.

NOTE

- It is recommended that users use their own certificates. If the certificate is not replaced, the security risk warning will be displayed during each login.
- After logging in to the WebUI, you can import a certificate under **Network Security Certification** on the [7.12.3 Setting Security Parameters](#) page.
- The imported security certificate needs to be bound to the SmartLogger IP address. Otherwise, the security risk warning will still be displayed during login.

Figure 7-5 Security risk warning

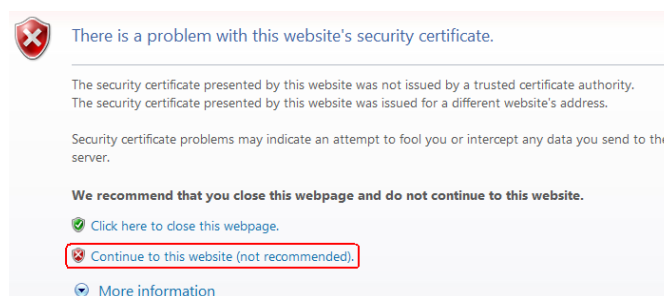

Procedure

Step 1 Enter **https://XX.XX.XX.XX** in the address box of the browser, and press **Enter**. The login page is displayed.

Figure 7-6 Login page

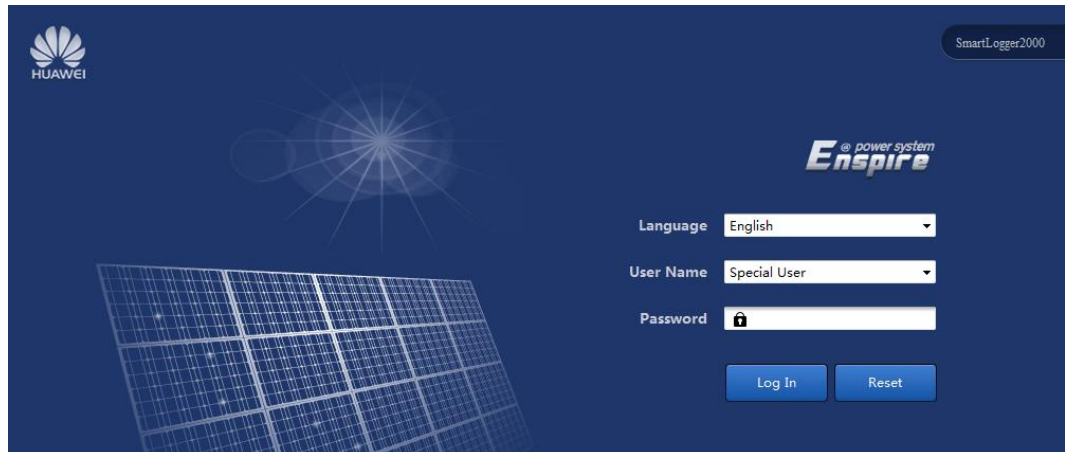

NOTE

XX.XX.XX.XX is the IP address for the SmartLogger. For example, the default IP address for the SmartLogger is <https://192.168.0.10>.

Step 2 Specify **Language**, **User Name**, and **Password**, and then click **Log In**.

NOTE

- The initial password is *Changeme* for system users **Common User**, **Advanced User**, and **Special User**.
- After the first login, change the initial password immediately to ensure account security.
- If you enter wrong passwords for five consecutive times in 5 minutes, your account will be locked out. You have to try again with the account 10 minutes later.

NOTICE

If any page is blank or a menu cannot be accessed after you log in to the WebUI, clear the cache, refresh the page, or log in again.

----End

7.4 WebUI Menu

The WebUI varies with the role that you use to log in.

NOTE

- indicates that the user has permission to operate the menu; ○ indicates that the user does not have permission to operate the menu.

Table 7-1 Users and permissions on the WebUI

Menu	Common	Advanced	Special User
------	--------	----------	--------------

Main Menu	Second-Level Menu	Third-Level Menu	Fourth-Level Menu	User	User		
Deployment Wizard	N/A	N/A	N/A	○	●	●	
Over View	Plant Running Info.	N/A	N/A	●	●	●	
	Active Alarm	N/A	N/A	●	●	●	
	Plant Yield	N/A	N/A	●	●	●	
	Performance Data	N/A	N/A	●	●	●	
	Device Running Info.	N/A	N/A	●	●	●	
Monitoring	SmartLogger 2000	Running Info.	N/A	●	●	●	
		Active Alarm	N/A	●	●	●	
		About	N/A	●	●	●	
	SUN2000 ^a	Running Info.	N/A	●	●	●	
		Active Alarm	N/A	●	●	●	
		Performance Data	N/A	●	●	●	
		Yield	N/A	●	●	●	
		Running Param.	Grid Parameters		○	●	●
			Protect Parameters		○	●	●
			Feature Parameters		○	●	●
			PV string access detection		○	●	○
	Power Adjustme			○	○	●	

Menu				Common User	Advanced User	Special User
Main Menu	Second-Level Menu	Third-Level Menu	Fourth-Level Menu			
			nt			
		Tracking System	N/A	○	●	○
		Characteristic Curve	N/A	○	○	●
		About	N/A	●	●	●
	MBUS	Running Info.	N/A	●	●	●
		STA List	N/A	○	●	○
		Networking Settings	N/A	○	●	○
		About	N/A	●	●	●
	EMI	Running Info.	N/A	●	●	●
		Performance Data	N/A	●	●	●
		Running Param.	N/A	○	●	○
		About	N/A	●	●	●
	Power Meter ^b	Running Info.	N/A	●	●	●
		Performance Data	N/A	●	●	●
		Running Param.	N/A	○	●	○
		About	N/A	●	●	●
	PID	Running Info.	N/A	●	●	●
		Active Alarm	N/A	●	●	●
		Performance Data	N/A	●	●	●
		Running Param.	N/A	○	●	○
		About	N/A	●	●	●

Menu				Common User	Advanced User	Special User
Main Menu	Second-Level Menu	Third-Level Menu	Fourth-Level Menu			
	PID-PVBOX	Running Info.	N/A	●	●	●
		Active Alarm	N/A	●	●	●
		Performance Data	N/A	●	●	●
		Running Param.	N/A	○	●	○
		About	N/A	●	●	●
	PID-SSC	Running Info.	N/A	●	●	●
		Active Alarm	N/A	●	●	●
		Performance Data	N/A	●	●	●
		Running Param.	N/A	○	●	○
		About	N/A	●	●	●
	STS	Teleindication	N/A	●	●	●
		Telemetry	N/A	●	●	●
		Telecontrol	N/A	○	●	○
		Performance Data	N/A	●	●	●
		Running Param.	N/A	○	●	○
	Custom Device, IEC103 Device, or IEC104 Device	Running Info.	N/A	●	●	●
		Teleindication	N/A	●	●	●
		Telemetry	N/A	●	●	●
		Telecontrol	N/A	●	●	●















Menu				Common User	Advanced User	Special User
Main Menu	Second-Level Menu	Third-Level Menu	Fourth-Level Menu			
		Teleadjust	N/A	●	●	●
Query	Alarm History	N/A	N/A	●	●	●
	Operation Log	N/A	N/A	○	●	●
	Export Data	N/A	N/A	○	●	●
Settings	User Param.	Date&Time	N/A	●	●	○
		Plant	N/A	●	●	○
		Revenue	N/A	●	●	○
		Save Period	N/A	●	●	○
		Bluetooth	N/A	○	●	○
	Comm. Param.	Wired Network	N/A	○	●	○
		RS485	N/A	○	●	●
		Power Meter	N/A	○	●	●
		Management System	N/A	○	●	○
		Modbus TCP	N/A	○	●	●
		IEC103	N/A	○	●	○
		IEC104	N/A	○	●	○
	Extended Param.	FTP	N/A	○	●	○
		Email	N/A	○	●	○
	Port Settings	DO	N/A	○	●	○
		USB	N/A	○	●	○
	Alarm Output	N/A	N/A	○	●	○
	Smart Tracking Algorithm	N/A	N/A	○	●	○
	Active Power Control	N/A	N/A	○	○	●



Menu				Common User	Advanced User	Special User
Main Menu	Second-Level Menu	Third-Level Menu	Fourth-Level Menu			
	Reactive Power Control	N/A	N/A	○	○	●
	Remote Shutdown	N/A	N/A	○	○	●
	DI	N/A	N/A	○	○	●
	Export Limitation	N/A	N/A	○	○	●
	Smart Reactive Power Compensation	N/A	N/A	○	○	●
Maintenance	Firmware Upgrade	N/A	N/A	○	●	●
	Product Information	N/A	N/A	●	●	●
	Security Settings	N/A	N/A	●	●	●
	System Maint.	N/A	N/A	○	●	●
	Device Log	N/A	N/A	○	●	●
	Onsite Test	Inspection	N/A	○	●	●
		Spot-check ^c	N/A	○	●	●
	License Management	N/A	N/A	○	●	●
	Device Mgmt.	Connect Device	N/A	○	●	●
		Device List	N/A	○	●	●
		Export Param.	N/A	○	●	●
		Clear Alarm	N/A	○	●	●
		Collect Perf. Data	N/A	○	●	●
	Adjust total energy yield	N/A	○	●	●	

 NOTE

- a: In the SUN2000, **Tracking System** and **Characteristic Curve** are only available for 1100 V and 1500 V inverters.
- b: The electricity meter can support standard Modbus-RTU or DL/T645. **Running Param.** is only available for the electricity meter that supports DL/T645.
- c: The spot-check function is available only for the inverter for which **Grid Code** is set to **Japan standard**.

7.5 Icon Description

Icon	Description	Icon	Description
	Click the About icon to query the WebUI version information.	 	Click the Drop-down icon to select a parameter or time.
	Click the Exit icon to log out.		Alarms are classified into major, minor, and warning ones. Click the Alarm icon to query an alarm.
	Click the Increase/Decrease icon to adjust time.		Click the Start icon to start the device.
	The Select icon indicates that a parameter is selected.		Click the Stop icon to shut down the device.
	The Select icon indicates that a parameter is not selected. Click the icon to select a parameter.		Click the Reset icon to reset the device.
	Hide icon and Display icon.		<ul style="list-style-type: none"> • The solar inverter is in On-grid state. • The device such as the EMI, power meter, slave SmartLogger, or MBUS is in Online state. • The PID is in Running state.
	The device is in Disconnection state. If a device is in Disconnection state, its parameters cannot be set.		The solar inverter is in Loading state.

Icon	Description	Icon	Description
	<ul style="list-style-type: none"> The solar inverter is in Initializing, Power-off, Idle, or other state in which it is not feeding power into the grid. The PID device is in Power-off, Idle or other state in which it is not running properly. 		Ascending order or descending order icon. Click the icon to sort the items in ascending or descending order for the corresponding column.

7.6 WebUI Layout

Figure 7-7 WebUI layout

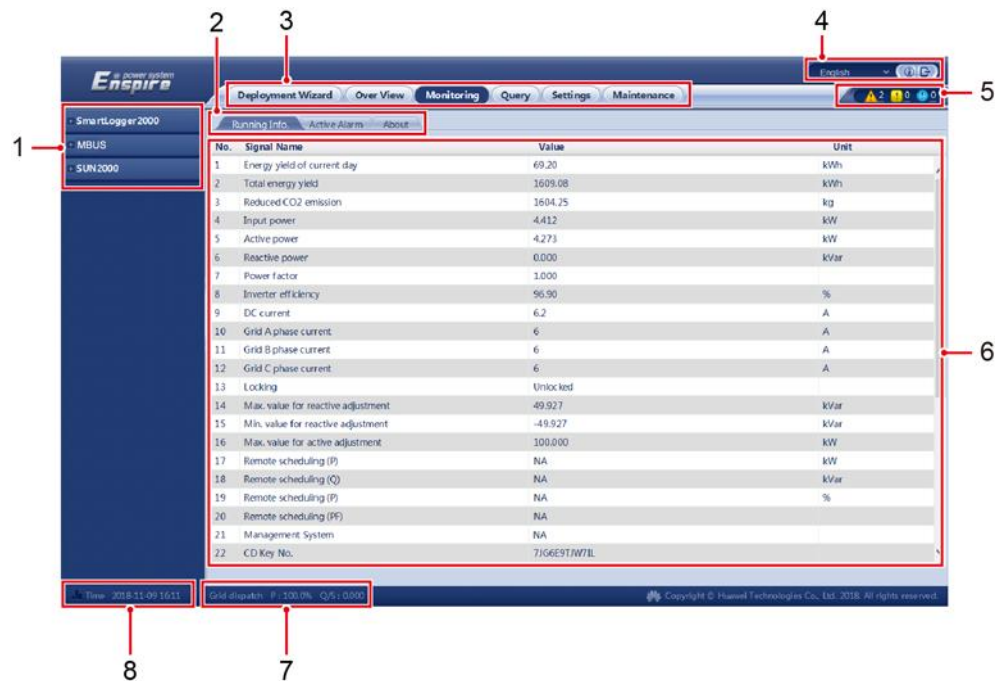

Table 7-2 WebUI layout description

No.	Function	Description
1	Secondary navigation menu	Under the primary navigation menu, choose the device to be queried or the parameter to be set under the secondary navigation menu.
2	Tertiary	After choosing a secondary menu, choose a tertiary menu

No.	Function	Description
	navigation menu ^a	to access the query or setting screen.
3	Primary navigation menu	Click the corresponding primary navigation menu before you perform any operation over the WebUI.
4	Display language	Select the display language or choose to log out.
5	Alarm icon	Displays the severities and number of alarms in the system. You can access the alarm page by clicking the number.
6	Details page	Displays the details of the queried information or parameter settings.
7	Power grid scheduling status	Displays the current power grid scheduling mode of the system.
8	System time	Displays the current system time.
a: There are no tertiary navigation menus under certain secondary navigation menus.		

7.7 Performing Deployment Wizard

Context

The SmartLogger supports the deployment wizard for configuring basic SmartLogger parameters, connecting Huawei devices, power meters, and EMIs, configuring Huawei NMS, and interworking with third-party devices.

Procedure

- Step 1** Log in as **Advanced User** or **Special User** to access the deployment wizard page.
- Step 2** Set parameters as prompted. For details, click **Help** on the page.

NOTE

When setting parameters, click **Previous**, **Next**, and **Skip** as required.

Figure 7-8 Deployment wizard

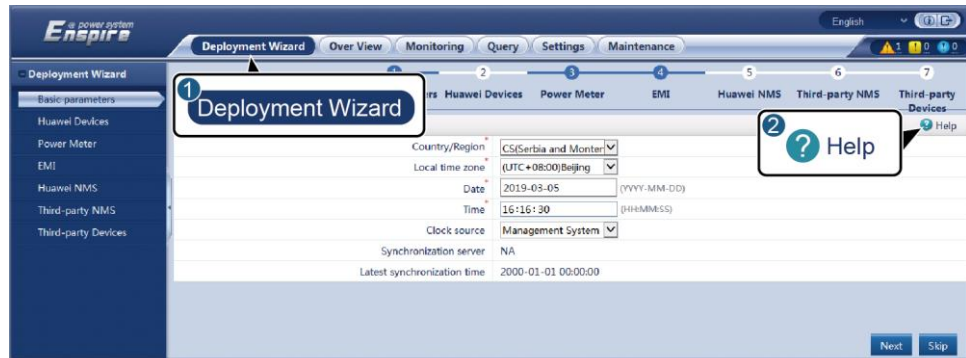

IL03J00003

Step 3 After setting parameters, click **Finish**.

----End

7.8 Overview

7.8.1 Plant Running Information

Choose **Over View > Plant Running Info.** and query information on the displayed page.

Figure 7-9 Plant running information

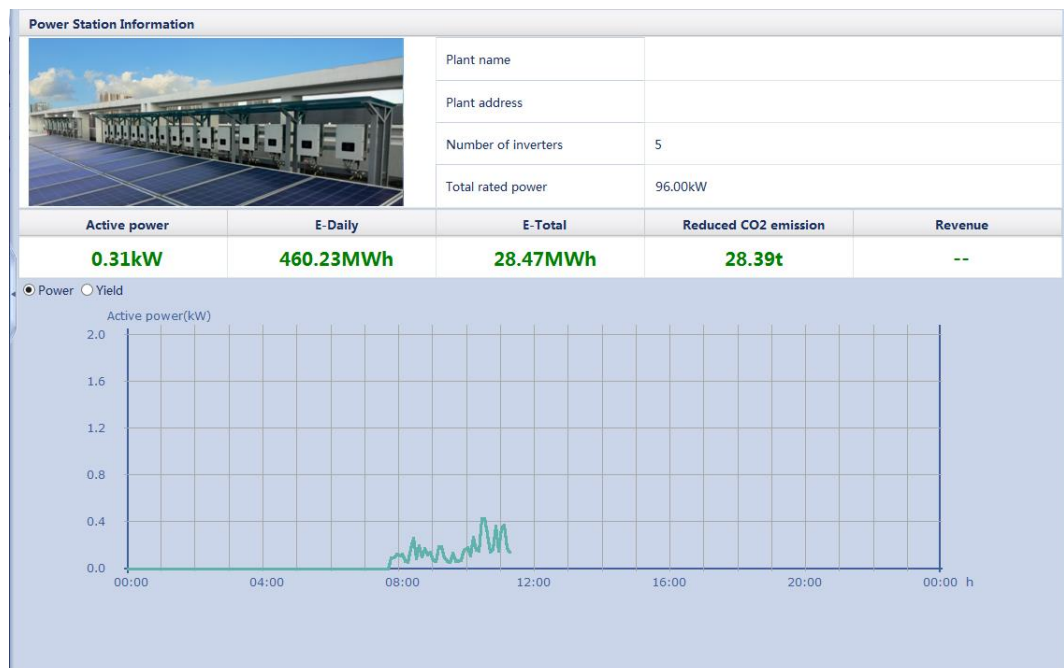

 **NOTE**

The PV plant running information contains only the information about all the Huawei SUN2000s connected to the SmartLogger.

7.8.2 Active Alarm

Choose **Over View** > **Active Alarm** and query alarms on the displayed page.

Figure 7-10 Active alarm

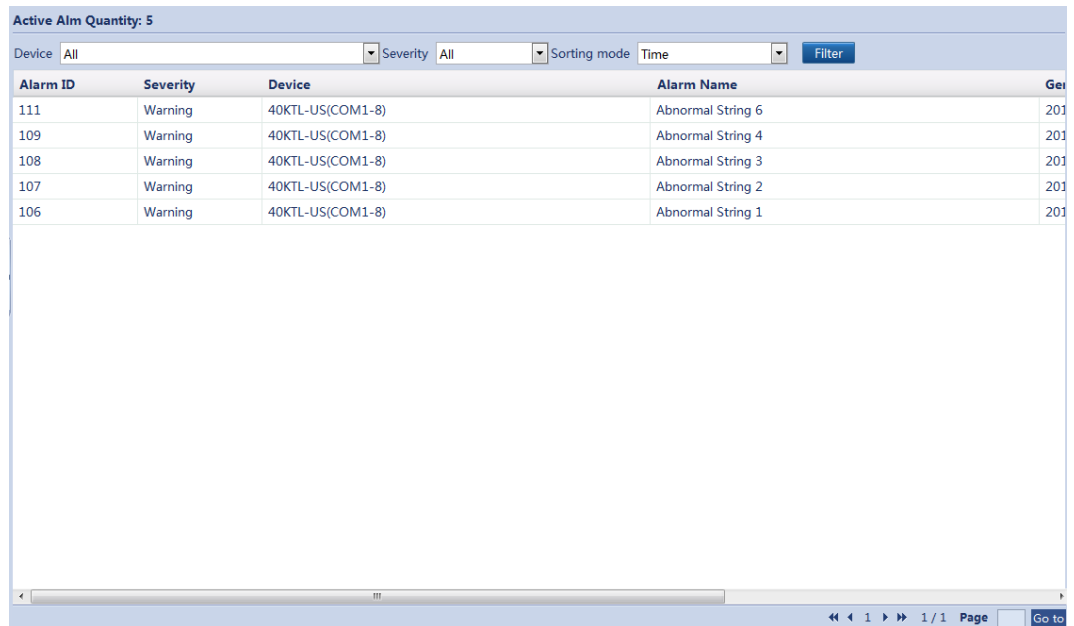

Active Alm Quantity: 5

Device: All | Severity: All | Sorting mode: Time | Filter

Alarm ID	Severity	Device	Alarm Name	Gen
111	Warning	40KTL-US(COM1-8)	Abnormal String 6	201
109	Warning	40KTL-US(COM1-8)	Abnormal String 4	201
108	Warning	40KTL-US(COM1-8)	Abnormal String 3	201
107	Warning	40KTL-US(COM1-8)	Abnormal String 2	201
106	Warning	40KTL-US(COM1-8)	Abnormal String 1	201

Navigation: << < 1 > >> 1 / 1 Page Go to

7.8.3 Plant Yield

Choose **Over View** > **Plant Yield** and query energy yield data on the displayed page.

Figure 7-11 Plant yield

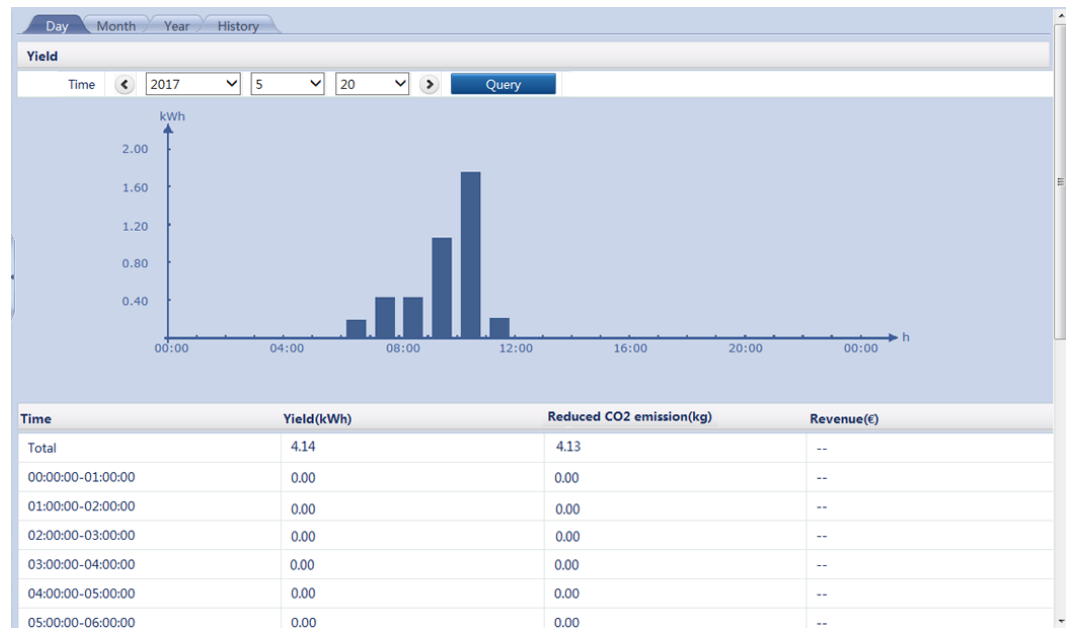

NOTE

You can click a tab on the tertiary navigation menu to query the energy yield data of the specified period.

NOTICE

- The daily energy yields can be stored for 30 days on an hourly basis.
- The monthly energy yields can be stored for 1 year on a daily basis.
- The yearly energy yields can be stored for 10 years on a monthly basis.
- The historical energy yields can be stored for 25 years on a yearly basis.

7.8.4 Performance Data

Choose **Over View > Performance Data** and query related information on the displayed page.

Figure 7-12 Performance data

Table Curve Export
 Time < 2017 5 20 >

Query

Generation time	E-Daily(kWh)	Input power(kW)	Active power(kW)	
2017-5-20 00:00:00	0.00	3.549	3.415	22.
2017-5-20 00:05:00	2.68	3.548	3.449	22.
2017-5-20 00:10:00	5.37	3.582	3.407	22.
2017-5-20 00:15:00	8.07	3.493	3.359	22.
2017-5-20 00:20:00	10.76	3.476	3.402	22.
2017-5-20 00:25:00	13.46	3.478	3.374	22.
2017-5-20 00:30:00	16.17	3.466	3.421	22.
2017-5-20 00:35:00	18.86	3.542	3.397	22.
2017-5-20 00:40:00	21.57	3.535	3.440	22.
2017-5-20 00:45:00	24.27	3.506	3.412	22.
2017-5-20 00:50:00	26.94	3.581	3.447	22.
2017-5-20 00:55:00	29.64	3.582	3.418	22.

1 / 11 Page Go to

NOTE

- You can click an option in the upper left corner of the page to display the data in the specified format or export the data.
- When changing the name of the exported file after data is exported, retain the extension **.tar.gz**. Otherwise, the file will be unusable.

7.8.5 Device Running Information

Choose **Over View > Device Running Info.** to enter the page. You can check or import the device running information here.

Figure 7-13 Device running information

Device	Address	Device status	E-Daily(kWh)	Active power(kW)	Reactive power(kVar)
28KTL(COM6-1)	6-1	Disconnection	0.00	0.000	0.000
40KTL(COM6-2)	6-2	Disconnection	0.00	0.000	0.000
30KTL-US(COM6-3)	6-3	Disconnection	0.00	0.000	0.000
50KTL(COM6-4)	6-4	Disconnection	0.00	0.000	0.000
40KTL-US(COM6-5)	6-5	Disconnection	0.00	0.000	0.000
45KTL-US(COM6-7)	6-7	Disconnection	0.00	0.000	0.000

7.9 Device Monitoring

7.9.1 SmartLogger

7.9.1.1 Querying Master SmartLogger-Related Information

Choose **Monitoring > Logger(Local)** and query master SmartLogger-related information on the displayed page.

Figure 7-14 Querying master SmartLogger-related information

No.	Signal Name	Value	Unit
1	Energy yield of current day	0.00	kWh
2	Total energy yield	0.00	kWh
3	Reduced CO2 emission	0.00	kg
4	Input power	0.000	kW
5	Active power	0.000	kW
6	Reactive power	0.000	kVar
7	Power factor	0.000	
8	Inverter efficiency	0.00	%
9	DC current	0.0	A
10	Grid A phase current	0	A
11	Grid B phase current	0	A
12	Grid C phase current	0	A
13	Locking	Locked	
14	Max. value for reactive adjustment	0.000	kVar
15	Min. value for reactive adjustment	0.000	kVar
16	Max. value for active adjustment	0.000	kW
17	Remote scheduling (P)	NA	kW
18	Remote scheduling (Q)	NA	kVar
19	Remote scheduling (P)	NA	%
20	Remote scheduling (PF)	NA	
21	Management System	NA	
22	CD Key No.	EISQGN6G395E	
23	NMS1 IP	NA	
24	NMS2 IP	NA	
25	NMS3 IP	NA	
26	NMS4 IP	NA	
27	NMS5 IP	NA	
28	IEC104-1 IP	NA	

NOTE

You can click a tab on the tertiary navigation menu to query master SmartLogger-related information.

7.9.1.2 Querying Slave SmartLogger-Related Information

Select a slave SmartLogger on the **Monitoring** tab page to query its information.

Figure 7-15 Querying slave SmartLogger-related information

No.	Signal Name	Value	Unit
1	SN	2102311NAE10G6000029	
2	IP Address	192.168.0.10	
3	Device status	OnLine	
4	Logical addr.	12	

7.9.2 SUN2000

7.9.2.1 Querying Related Information

Choose **Monitoring** > **SUN2000** and query related information on the displayed page.

Figure 7-16 Querying SUN2000-related information

No.	Signal Name	Value	Unit
1	Device status	Grid dispatch: cos(Phi)-P curve	
2	Rated power	50.000	kW
3	Energy yield of current day	1.43	kWh
4	Total energy yield	53676.87	kWh
5	Reduced CO2 emission	53515.83	kg
6	Input power	0.000	kW
7	Active power	0.000	kW
8	Reactive power	0.000	kVar
9	Power factor	0.000	
10	PV1/PV2/PV3/PV4/PV5/PV6/PV7/PV8 voltage	588.3/588.3/586.9/586.9/588.0/588.0/148.3/148.3	V
11	PV9/PV10/PV11/PV12 voltage	148.2/148.2/147.8/147.8	V
12	PV1/PV2/PV3/PV4/PV5/PV6/PV7/PV8 current	-0.05/0.04/0.00/0.02/-0.02/0.04/0.00/0.00	A
13	PV9/PV10/PV11/PV12 current	0.00/0.00/0.00/0.00	A
14	Grid AB/BC/CA voltage	517.7/517.6/515.0	V
15	Grid A/B/C phase current	0.011/0.011/0.011	A
16	Grid frequency	49.99	Hz
17	Cabinet temperature	32.3	degC
18	Locking	Locked	
19	Startup time	2019-01-14 10:14:00	
20	Shutdown time	2019-01-13 00:46:30	
21	Collect DSP data	Normal	
22	Active power adjustment	P = 100.0%(Active power deration percent)	
23	Reactive power adjustment	Q: cos(Phi)-P curve	

NOTE

- You can click the **Running Info.**, **Active Alarm**, **Performance Data**, **Yield** or **About** tab on the tertiary navigation menu to query SUN2000-related information.
- You can click the Start, Stop, or Reset icon to send the corresponding command to the SUN2000.

7.9.2.2 Setting Running Parameters (Advanced User)

Settings Page

NOTE

Before setting the running parameters of the solar inverter, ensure that the DC side is energized.

Because of permission restriction, log in as **Advanced User**. Choose **Device Monitoring** > **SUN2000** > **Running Parameters** to go to the settings page.

Figure 7-17 Running parameters (advanced user)

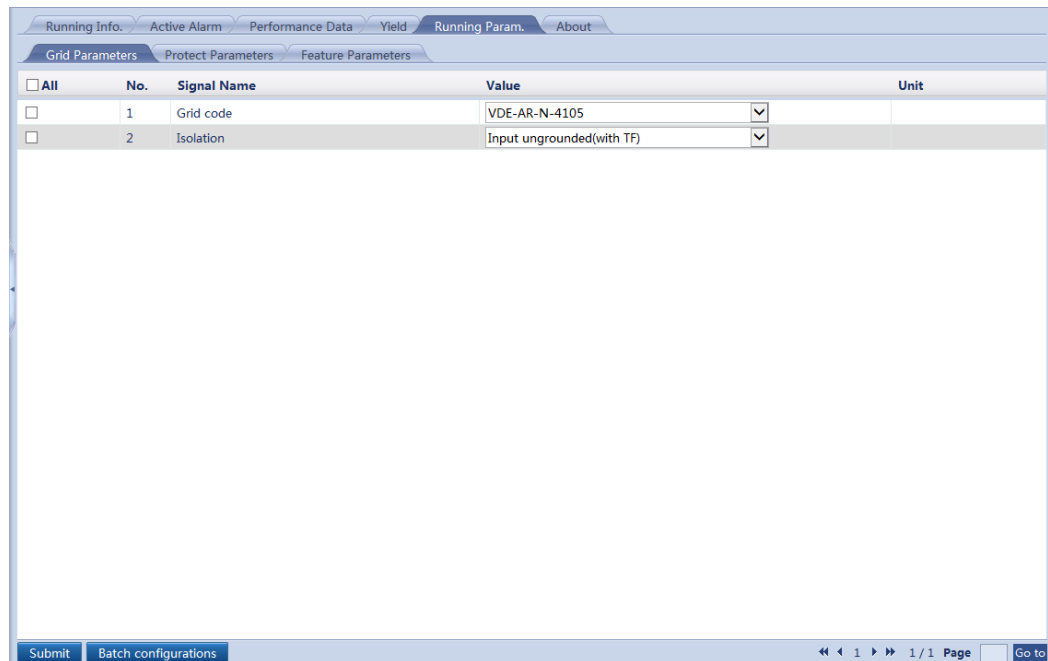

NOTE

- The parameter list provided in this document includes all configurable parameters. Configurable parameters vary with the device model and grid code. The actual page prevails.
- Changing the grid code may restore some parameters to factory defaults. Check whether the previously set parameters are affected.

Power Grid Parameters

Table 7-3 Parameter description

Parameter	Parameter Description
Grid code	Set this parameter based on the power grid code of the country or region where the solar inverters are located and the application scenario.
Isolation	Specifies the working mode of the solar inverter based on the grounding status on the DC side and the connection to the power grid.

Protection Parameters

Table 7-4 Parameter description

Parameter	Parameter Description
Insulation resistance protection	To ensure device safety, the solar inverter detects the insulation resistance of the input side with respect to ground when it starts a self-check. If the detected value is less than the preset value, the solar inverter does not connect to the grid.

Feature Parameters

Table 7-5 Parameter description

Parameter	Parameter Description	Remarks
MPPT multi-peak scanning	When the solar inverter is used in scenarios where PV strings are obviously shaded, set this parameter to Enable , and then the solar inverter will perform MPPT scanning at regular intervals to locate the maximum power.	The scanning interval is set by MPPT scanning interval .
MPPT scanning interval	Specifies the MPPT scanning interval.	This parameter is displayed only when MPPT multi-peak scanning is set to Enable .
RCD enhancing	RCD refers to the residual current of the solar inverter to the ground. To ensure device and personal safety, RCD should be limited to the specified value in the standard. If an AC switch with a residual current detection function is installed outside the solar inverter, you need to set this function to Enable to reduce the residual current generated during solar inverter running, thereby preventing the AC switch from misoperations.	N/A
Reactive power output at night	In some specific application scenarios, a power grid company requires that the solar inverter can perform reactive power compensation at night to ensure that the power factor of the local power grid meets requirements.	This parameter is available only when Isolation is set to Input ungrounded (with TF) .
Strong adaptability	If the value of power grid short circuit capacity/power plant installed capacity is less than 3 and the power grid impedance is too high, the power grid quality will be affected and the solar inverter may be unable to run properly. Set Strong adaptability to Enable .	N/A
Power quality optimization mode	If Power quality optimization mode is set to Enable , the output current harmonics of the solar inverter will be optimized.	N/A
PV module type	Specifies the type of PV modules.	<ul style="list-style-type: none">If PV module type is set to Crystalline silicon or Film, the solar inverter will run properly and will not shut down if PV modules are shaded.

Parameter	Parameter Description	Remarks
		<ul style="list-style-type: none"> If PV module type is set to CPV 1, the solar inverter can quickly restart in 60 minutes if the input power of PV modules drops drastically due to shading. If PV module type is set to CPV 2, the solar inverter can quickly restart in 10 minutes if the input power of PV modules drops drastically due to shading.
Crystalline silicon PV compensation mode	This parameter reduces the DC voltage of PV modules to the PE by reducing the impedance of the solar inverter input side to the PE, thereby effectively reducing the potential induced degradation (PID) effect of PV modules.	This parameter is displayed only when PV module type is set to Crystalline silicon . Set this parameter to P-type output for P-type PV modules and N-type output for N-type PV modules.
Communication interrupt shutdown	The standards of certain countries and regions require that the solar inverter shut down after the communication is interrupted for a certain time.	If Communication interrupt shutdown is set to Enable and the solar inverter communication has been interrupted for a specified time (set by Communication interruption duration), the solar inverter will automatically shut down.
Communication interruption duration	Specifies the duration for determining communication interruption. Used for automatic shutdown for protection in case of communication interruption.	N/A
Communication resumed startup	If this parameter is enabled, the solar inverter automatically starts after communication recovers. If this parameter is disabled, the solar inverter needs to be started manually after communication recovers.	This parameter is displayed only when Communication interrupt shutdown is set to Enable .
Soft start time	Specifies the duration for the power to gradually increase when the solar inverter starts.	The default value for Australian AS4777 grid code is 360 . The default value for Italian CEI0-21 and CEI0-16 grid codes is 300 . The default value for Egyptian EGYPT grid code is 600 .
AFCI	The North American standard requires that the solar inverter provide the DC arc detection function.	This parameter is supported by the solar inverters named with -US.
Arc detection adaptation mode	Adjusts the sensitivity of arc detection.	This parameter is supported by the solar inverters named with -US and is displayed only when AFCI is set to Enable .
AFCI self check	Send the AFCI self-check command manually.	
Current error during	To prevent inaccurate scanning caused by	N/A

Parameter	Parameter Description	Remarks
scanning	sunlight change, the current change of PV strings in normal working conditions should be monitored when the I-V curves of PV strings are being scanned. When the current exceeds the specified value, it is determined that the sunlight changes. The I-V curves should be scanned again.	
OVGR linked shutdown	If OVGR linked shutdown is set to Enable , the solar inverter shuts down after receiving the OVGR signal. If this parameter is set to Disable , the solar inverter does not shut down after receiving the OVGR signal.	This parameter is displayed only when the Japanese grid code is selected.
Dry contact function	Identifies the dry contact signals from the SmartLogger.	Set this parameter to OVGR for OVGR signals, and set it to NC for other signals. This parameter is displayed only when the Japanese grid code is selected.
Hibernate at night	The solar inverter monitors PV strings at night. If Hibernate at night is set to Enable , the monitoring function of the solar inverter will hibernate at night, reducing power consumption.	N/A
MBUS communication (PLC communication)	For solar inverter models that support both RS485 and MBUS (PLC) communication, when RS485 communication is used, you are advised to set MBUS communication to Disable to reduce power consumption.	<ul style="list-style-type: none"> • If Tracker controller is set to a manufacturer model, this parameter cannot be set to Disable. • If the solar inverter communicates with the SmartLogger over MBUS (PLC), this parameter cannot be set to Disable on the WebUI.
Upgrade delay	Upgrade delay is mainly used in the upgrade scenarios where the PV power supply is disconnected at night due to no light or unstable at dawn or dusk due to poor sunlight.	After the solar inverter upgrade starts, if Upgrade delay is set to Enable , the upgrade package is loaded first. After the PV power supply recovers and the activation conditions are met, the solar inverter automatically activates the upgrade.
String monitor	The solar inverter monitors PV strings in real time. If any PV string is abnormal (such as the PV string is shaded or the electric energy yield decreases), the solar inverter generates an alarm to remind maintenance personnel to maintain the PV string in a timely manner.	If PV strings are easily shaded, you are advised to set String monitor to Disable to prevent false alarms.
String detection low power delay	Specifies the delay time for generating abnormal string alarms when the solar inverter detects that a PV string is working with low power. This parameter is mainly	This parameter is displayed only when String monitor is set to Enable .

Parameter	Parameter Description	Remarks
	used in the scenario where PV strings are shaded for a long time in the morning and evening, and is used to prevent false alarms.	
String detection high power delay	Specifies the delay time for generating abnormal string alarms when the solar inverter detects that a PV string is working with high power.	
String detection power segment division percentage	Specifies the thresholds for determining whether a PV string is working with high power or low power. This parameter is used to distinguish the working status of PV strings.	
String detection reference asymmetric coefficient	Specifies the threshold for determining PV string exceptions. The false alarms caused by fixed shading can be controlled by changing this parameter.	
String detection starting power percentage	Specifies the threshold for starting PV string exception detection. The false alarms caused by fixed shading can be controlled by changing this parameter.	
Shutdown at 0% power limit	If Shutdown at 0% power limit is set to Enable , the solar inverter shuts down after receiving the 0% power limit command. If this parameter is set to Disable , the solar inverter does not shut down after receiving the 0% power limit command.	N/A
Maximum apparent power	Specifies the output upper threshold for the maximum apparent power to adapt to the capacity requirements of standard and customized solar inverters.	If the maximum active power equals S_{\max_limit} , this parameter is not displayed.
Maximum active power	Specifies the output upper threshold for the maximum active power to adapt to different market requirements.	This parameter can be set to 27.5 kW at most for the SUN2000-25KTL-US.
Tracker controller	Specifies the controller vendor.	N/A
Commanded shutdown hold after power recovery	The standards of certain countries and regions require that if the solar inverter is shut down after receiving a command and powered on again after power recovers, it should still be in commanded shutdown state.	N/A
String connection mode	Specifies the connection mode of PV strings.	N/A
PID protection at night	If the solar inverter outputs reactive power at night and this parameter is set to	N/A

Parameter	Parameter Description	Remarks
	Enable , the solar inverter will shut down automatically if it detects that the voltage compensation of the PID module is abnormal.	
RS485-2 communication	If this parameter is set to Enable , the RS485-2 port can be used. If the RS485-2 port is not used, you are advised to set this parameter to Disable to reduce power consumption.	N/A
PID running mode	Specifies the operation mode of the solar inverter built-in PID.	N/A
PID nighttime off-grid repair	Specifies whether to enable the PID nighttime off-grid repair.	N/A
PID daytime off-grid repair	Specifies whether to enable the PID daytime off-grid repair.	N/A

PV String Access Detection

- PV string access detection applies to large-scale commercial ground PV plants with PV strings facing the same direction.
- In AC or DC power limiting scenarios:
 - If the PV string access type has not been identified, **PV string access type** will be displayed as **Disconnection**. The PV string access type can be identified only when the solar inverters restore to the non-power limiting state and the current of all connected PV strings reaches the startup current.
 - If the PV string access type has been identified, when a certain PV string connected to the 2-in-1 terminals is lost, no alarm will be generated. If a certain PV string connected to the 2-in-1 terminals is restored, the access type cannot be identified. You can determine whether both 2-in-1 PV strings are restored only when the PV string current reaches **Startup current for 2-in-1 detection**.
- After setting the parameters, you can go to the **Running Info.** tab page to check whether the PV string connection status is normal.

Table 7-6 Parameter description

Parameter	Parameter Description
String Access Detection	String Access Detection is set to Disable by default. After solar inverters are connected to the power grid, set String Access Detection to Enable .
Startup current	When the current of all connected PV strings reaches the preset value, the PV string access detection function is enabled. NOTE Startup current setting rules: <ul style="list-style-type: none"> • Startup current = $I_{sc} (S_{tc}) \times 0.6$ (rounded up). For details about $I_{sc} (S_{tc})$, see the PV module nameplate. • Default startup current (5 A): applicable to the scenarios where the short-circuit

Parameter	Parameter Description
	current I_{sc} (S_{tc}) is greater than 8 A for the monocrystalline and polycrystalline PV modules.
Startup current for 2-in-1 detection	When the current of a PV string reaches Startup current for 2-in-1 detection , the PV string is automatically identified as 2-in-1 . You are advised to retain the default settings.
PV string N access type NOTE N is the DC input terminal number of the solar inverter.	Set this parameter based on the type of the PV string connected to DC input terminal N of the solar inverter. Currently, the options are as follows: Automatic identification (default value), Disconnection, Single PV string, and 2-in-1. You are advised to retain the default value. If the value is incorrectly set, the PV string access type may be incorrectly identified and alarms may be generated by mistake for the PV string access status.

7.9.2.3 Setting Running Parameters (Special User)

Settings Page

NOTE

Before setting the running parameters of the inverter, ensure that the DC side is energized.

Because of permission restriction, log in to the WebUI as a special user. Choose **Monitoring > SUN2000 > Running Param.** to access the setting page.

Figure 7-18 Running param. (special user)

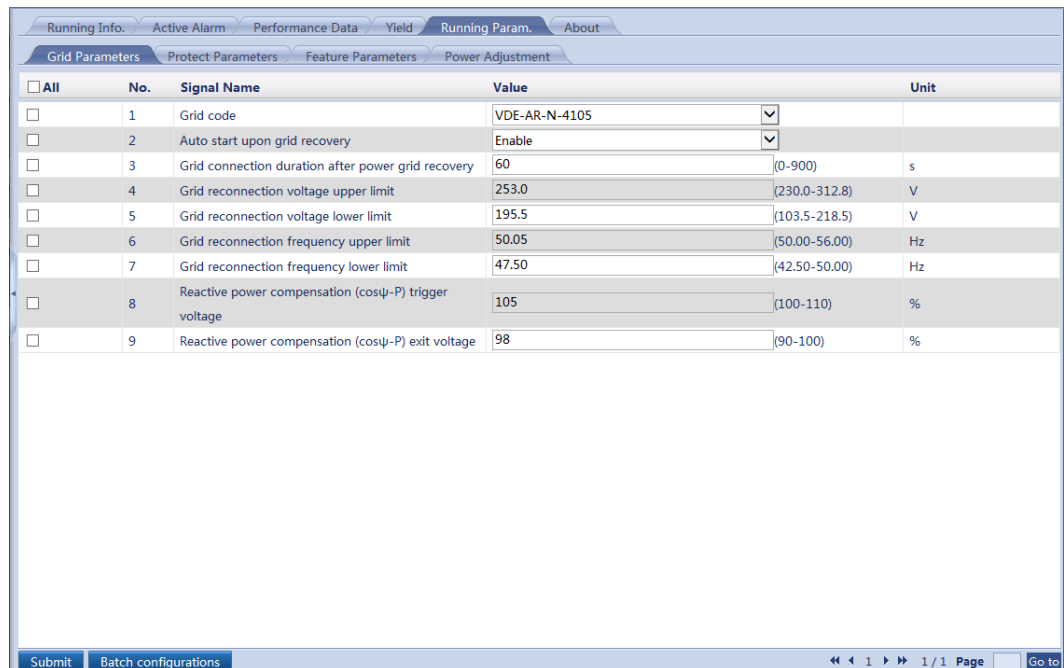

 NOTE

- The parameter list provided in this document includes all configurable parameters. Configurable parameters vary with the device model and grid code. The actual page prevails.
- Changing the grid code may restore some parameters to factory defaults. Check whether the previously set parameters are affected.

Grid Parameters

Table 7-7 Parameter description

Parameter	Description	Remarks
Grid code	Set this parameter based on the grid code of the country or region where the inverter is used and the inverter application scenario.	-
Output mode	Specifies whether the inverter has an output neutral wire based on the inverter application scenario.	Supported by the SUN2000-33KTL, SUN2000-33KTL-A, SUN2000-36KTL, SUN2000-50KTL-M0, SUN2000-60KTL-M0, and the inverters named with -US .
PQ mode	If PQ mode 1 is selected, the maximum AC output power equals the maximum apparent power. If PQ mode 2 is selected, the maximum AC output power equals the rated output power.	This parameter is supported by the SUN2000-36KTL, SUN2000-42KTL, SUN2000-50KTL-M0, and SUN2000-60KTL-M0.
Auto start upon grid recovery	Specifies whether to allow the inverter to automatically start after the power grid recovers.	-
Grid connection duration after power grid recovery	Specifies the waiting time for inverter restart after the power grid recovers.	The value range is [150, 900] if the Japanese grid code is selected.
Grid reconnection voltage upper limit	The standards of certain countries and regions require that the inverter must not connect to the power grid when the power grid voltage is higher than the upper limit.	Vn represents the rated voltage.
Grid reconnection voltage lower limit	The standards of certain countries and regions require that the inverter must not connect to the power grid when the power grid voltage is lower than the lower limit.	
Grid reconnection frequency upper limit	The standards of certain countries and regions require that the inverter must not connect to the power grid when the power grid frequency is higher than the upper limit.	Fn represents the rated frequency.
Grid reconnection frequency lower limit	The standards of certain countries and regions require that the inverter must not	

Parameter	Description	Remarks
	connect to the power grid when the power grid frequency is lower than the lower limit.	
Reactive power compensation (cosφ-P) trigger voltage	Specifies the voltage threshold for triggering reactive power compensation when LVRT occurs.	-
Reactive power compensation (cosφ-P) exit voltage	Specifies the voltage threshold for exiting reactive power compensation when the inverter recovers from LVRT.	-
Isolation	Specifies the inverter working mode based on the grounding status at the DC side and the connection to the power grid.	-

Protection Parameters

Table 7-8 Parameter description

Parameter	Description	Remarks
Unbalance voltage protection	Specifies the inverter protection threshold in the case of unbalanced power grid voltage.	-
Phase protection point	The Japanese standard requires that during passive islanding detection, protection should be triggered if an abrupt voltage phase change is detected.	Configurable abruptly changed phase angles are 3°, 6°, 9°, 12°, and 15°, which are displayed after the Japanese grid code is selected.
Phase angle offset protection	The standards of certain countries and regions require that the inverter needs to be protected when the three-phase angle offset of the power grid exceeds a certain value.	-
10 minute OV protection	Specifies the 10-minute overvoltage protection threshold.	Vn represents the rated voltage.
10 minute OV protection time	Specifies the 10-minute overvoltage protection duration.	
Level-1 OV protection	Specifies the level-1 overvoltage protection threshold.	Vn represents the rated voltage.
Level-1 OV protection time	Specifies the level-1 overvoltage protection duration.	
Level-2 OV protection	Specifies the level-2 overvoltage protection threshold.	Vn represents the rated voltage.
Level-2 OV protection time	Specifies the level-2 overvoltage protection duration.	
Level-1 UV protection	Specifies the level-1 undervoltage protection	Vn represents the rated voltage.

Parameter	Description	Remarks
	threshold.	
Level-1 UV protection time	Specifies the level-1 undervoltage protection duration.	
Level-2 UV protection	Specifies the level-2 undervoltage protection threshold.	Vn represents the rated voltage.
Level-2 UV protection time	Specifies the level-2 undervoltage protection duration.	
Level-1 OF protection	Specifies the level-1 overfrequency protection threshold.	Fn represents the rated frequency.
Level-1 OF protection time	Specifies the level-1 overfrequency protection duration.	
Level-2 OF protection	Specifies the level-2 overfrequency protection threshold.	Fn represents the rated frequency.
Level-2 OF protection time	Specifies the level-2 overfrequency protection duration.	
Level-1 UF protection	Specifies the level-1 underfrequency protection threshold.	Fn represents the rated frequency.
Level-1 UF protection time	Specifies the level-1 underfrequency protection duration.	
Level-2 UF protection	Specifies the level-2 underfrequency protection threshold.	Fn represents the rated frequency.
Level-2 UF protection time	Specifies the level-2 underfrequency protection duration.	
Level-3 OV protection	Specifies the level-3 overvoltage protection threshold.	<ul style="list-style-type: none"> In 1000 V inverters, only the inverters marked "-US" support this parameter. Vn represents the rated voltage.
Level-3 OV protection time	Specifies the level-3 overvoltage protection duration.	
Level-4 OV protection	Specifies the level-4 overvoltage protection threshold.	<ul style="list-style-type: none"> In 1000 V inverters, only the inverters marked "-US" support this parameter. Vn represents the rated voltage.
Level-4 OV protection time	Specifies the level-4 overvoltage protection duration.	
Level-3 UV protection	Specifies the level-3 undervoltage protection threshold.	<ul style="list-style-type: none"> In 1000 V inverters, only the inverters marked "-US" support this parameter. Vn represents the rated voltage.
Level-3 UV protection time	Specifies the level-3 undervoltage protection duration.	
Level-4 UV protection	Specifies the level-4 undervoltage protection threshold.	<ul style="list-style-type: none"> In 1000 V inverters, only the inverters marked "-US" support this parameter. Vn represents the rated voltage.
Level-4 UV protection time	Specifies the level-4 undervoltage protection duration.	

Parameter	Description	Remarks
Level-5 OV protection	Specifies the level-5 overvoltage protection threshold.	Vn represents the rated voltage.
Level-5 OV protection time	Specifies the level-5 overvoltage protection duration.	
Level-6 OV protection	Specifies the level-6 overvoltage protection threshold.	Vn represents the rated voltage.
Level-6 OV protection time	Specifies the level-6 overvoltage protection duration.	
Level-5 UV protection	Specifies the level-5 undervoltage protection threshold.	Vn represents the rated voltage.
Level-5 UV protection time	Specifies the level-5 undervoltage protection duration.	
Level-6 UV protection	Specifies the level-6 undervoltage protection threshold.	Vn represents the rated voltage.
Level-6 UV protection time	Specifies the level-6 undervoltage protection duration.	
Level-3 OF protection	Specifies the level-3 overfrequency protection threshold.	Fn represents the rated frequency.
Level-3 OF protection time	Specifies the level-3 overfrequency protection duration.	
Level-4 OF protection	Specifies the level-4 overfrequency protection threshold.	Fn represents the rated frequency.
Level-4 OF protection time	Specifies the level-4 overfrequency protection duration.	
Level-5 OF protection	Specifies the level-5 overfrequency protection threshold.	Fn represents the rated frequency.
Level-5 OF protection time	Specifies the level-5 overfrequency protection duration.	
Level-6 OF protection	Specifies the level-6 overfrequency protection threshold.	Fn represents the rated frequency.
Level-6 OF protection time	Specifies the level-6 overfrequency protection duration.	
Level-3 UF protection	Specifies the level-3 underfrequency protection threshold.	Fn represents the rated frequency.
Level-3 UF protection time	Specifies the level-3 underfrequency protection duration.	
Level-4 UF protection	Specifies the level-4 underfrequency protection threshold.	Fn represents the rated frequency.
Level-4 UF protection	Specifies the level-4 underfrequency	

Parameter	Description	Remarks
time	protection duration.	
Level-5 UF protection	Specifies the level-5 underfrequency protection threshold.	Fn represents the rated frequency.
Level-5 UF protection time	Specifies the level-5 underfrequency protection duration.	
Level-6 UF protection	Specifies the level-6 underfrequency protection threshold.	Fn represents the rated frequency.
Level-6 UF protection time	Specifies the level-6 underfrequency protection duration.	

Feature Parameters

Table 7-9 Parameter description

Parameter	Description	Remarks
LVRT	When the power grid voltage is abnormally low for a short time, the inverter cannot disconnect from the power grid immediately and has to work for some time. This is called LVRT.	This parameter is set to Enable by default if the German BDEW-MV grid code is selected.
LVRT threshold	Specifies the threshold for triggering LVRT. The threshold settings should meet the standard requirements for the local grid.	This parameter is displayed when LVRT is set to Enable . Vn represents the rated voltage.
LVRT undervoltage protection shield	Specifies whether to shield the undervoltage protection function during LVRT.	This parameter is displayed when LVRT is set to Enable .
LVRT reactive power compensation power factor	During LVRT, the inverter needs to generate reactive power to support the power grid. This parameter is used to set the reactive power generated by the inverter.	This parameter is displayed when LVRT is set to Enable . This parameter is set to 2.5 by default if the South African grid code is selected. For example, if you set LVRT reactive power compensation power factor to 2 , the reactive power generated by the inverter is 20% of the rated power when the AC voltage drops by 10% during LVRT.
HVRT	When the power grid voltage is abnormally high for a short time, the inverter cannot disconnect from the power grid immediately and has to work for some time. This is called HVRT.	-
HVRT triggering	Specifies the threshold for triggering the	This parameter is displayed when

Parameter	Description	Remarks
threshold	HVRT. The threshold settings should meet the local grid standard.	HVRT is set to Enable .
Active islanding	Specifies whether to enable the active islanding protection function.	-
Passive islanding	Specifies whether to enable the passive islanding protection function.	This parameter is displayed after the Japanese grid code is selected.
Voltage rise suppression	The standards of certain countries and regions require that the inverter must generate a certain amount of reactive power when the output voltage exceeds a certain value.	This parameter is set to Enable by default if the Italian grid code CEIO-16 is selected.
Voltage rise suppression reactive adjustment point	The standards of certain countries and regions require that the inverter must generate a certain amount of reactive power when the output voltage exceeds a certain value.	<ul style="list-style-type: none"> This parameter is displayed when Voltage rise suppression is set to Enable. The value of Voltage rise suppression active derating point must be greater than that of Voltage rise suppression reactive adjustment point.
Voltage rise suppression active derating point	The standards of certain countries and regions require that the inverter must generate a certain amount of reactive power when the output voltage exceeds a certain value.	
Frequency change rate protection	The inverter triggers protection when the power grid frequency changes too fast.	N/A
Frequency change rate protection point	Specifies the frequency change rate protection threshold.	This parameter is displayed if Frequency change rate protection is set to Enable .
Frequency change rate protection time	Specifies the frequency change rate protection duration.	This parameter is displayed if Frequency change rate protection is set to Enable .
Soft start time after grid failure	Specifies the time for the power to gradually increase when the inverter restarts after the power grid recovers.	This parameter is set to 360 by default if the Australian AS4777 grid code is selected, and to 300 by default if the Brazilian ABNT NBR 16149 or South African SA_RPPs grid code is selected.
Zero current due to power grid fault	Specifies the working mode of the solar inverter during LVRT or HVRT. If this parameter is set to Enable , the output current of the solar inverter will be less than 10% of the rated current during LVRT or HVRT.	N/A

Power Adjustment Parameters

Table 7-10 Parameter description

Parameter	Description	Remarks
Active power change gradient	Adjusts the change speed of the inverter active power.	-
Fixed active power derated	Adjusts the active power output of the inverter in fixed values.	<ul style="list-style-type: none"> • Pmax represents the maximum active power. • For 1000 V inverters, the maximum value of this parameter for the SUN2000-25KTL-US is 27.5 kW. • This parameter is for the SUN2000-100KTL-USH0 only and displayed when Remote power schedule is set to Enable.
Active power percentage derating	Adjusts the active power output of the inverter in percentages.	<ul style="list-style-type: none"> • If this parameter is set to 100, the inverter delivers the maximum output power. • This parameter is for the SUN2000-100KTL-USH0 only and displayed when Remote power schedule is set to Enable.
Reactive power change gradient	Adjusts the change speed of the inverter reactive power.	-
Power factor	Adjusts the power factor of the inverter.	This parameter is for the SUN2000-100KTL-USH0 only and displayed when Remote power schedule is set to Enable .
Overfrequency derating	If this parameter is enabled, the active power of the inverter will be derated according to a certain slope when the grid frequency exceeds the frequency that triggers overfrequency derating.	-
Trigger frequency of over frequency derating	The standards of certain countries and regions require that the output active power of the inverter be derated when the power grid frequency exceeds a certain value.	<ul style="list-style-type: none"> • This parameter is for the inverters except the 1000 V ones. It is displayed when Overfrequency derating is set to Enable.
Quit frequency of over frequency derating	Specifies the frequency threshold for exiting overfrequency derating.	<ul style="list-style-type: none"> • The parameter setting should meet the following condition: Quit frequency of over frequency derating ≤ Trigger frequency of over frequency derating < Cutoff frequency of overfrequency derating.
Cutoff frequency of	Specifies the frequency threshold for cutting	<ul style="list-style-type: none"> • This parameter is displayed when

Parameter	Description	Remarks
overfrequency derating	off overfrequency derating.	<p>Overfrequency derating is set to Enable.</p> <ul style="list-style-type: none"> The parameter setting should meet the following condition: Quit frequency of over frequency derating ≤ Trigger frequency of over frequency derating < Cutoff frequency of overfrequency derating.
Cutoff power of overfrequency derating	Specifies the power threshold for cutting off overfrequency derating.	
Power recovery gradient of overfrequency derating	Specifies the power recovery gradient for overfrequency derating.	This parameter is set to 16 by default if the Australian AS4777 grid code is selected, and to 15 by default if the Italian CEIO-21 or CEIO-16 grid code is selected.
Remote power schedule	<ul style="list-style-type: none"> If this parameter is set to Enable, the inverter responds to the scheduling instruction from the remote port. If it is set to Disable, the inverter does not respond to the scheduling instruction from the remote port. If users set this parameter to Disable, it is recommended that the SmartLogger V200R002C10SPC100 or later versions be used to ensure to precision of grid scheduling values. 	-
Schedule instruction valid duration	Adjusts the duration within which the scheduling instruction is valid.	If this parameter is set to 0 , the instruction is valid permanently.
Maximum apparent power	Specifies the output upper threshold for the maximum apparent power to adapt to the capacity requirements for standard and customized transformers.	If the maximum active power equals Smax_limit, this parameter is not displayed.
Maximum active power	Specifies the output upper threshold for the maximum active power to adapt to various market requirements.	-
Shutdown at 0% power limit	If this parameter is set to Enable , the inverter shuts down after receiving the 0% power limit command. If this parameter is set to Disable , the inverter does not shut down after receiving the 0% power limit command.	-
Reactive power compensation (Q/S)	Adjusts the inverter output reactive power.	This parameter is for the SUN2000-100KTL-USH0 only and displayed when Remote power schedule is set to Enable .
Reactive power output at night	In some specific application scenarios, a power grid company requires that the inverter can perform reactive power	This parameter is available only when Isolation is set to Input

Parameter	Description	Remarks
	compensation at night to ensure that the power factor of the local power grid meets requirements.	ungrounded (with TF).

Reference power parameters

Table 7-11 Parameter description

Parameter	Description
Apparent power baseline (kVA)	Adjust the apparent output baseline of the inverter.
Active power baseline (kW)	Adjusts the active output baseline of the inverter.

7.9.2.4 Setting a Tracking System

If a PV string uses a tracking system with controllers, you can set parameters for the tracking system over the WebUI.

 **NOTE**

- The parameters vary depending on the controller manufacturer. Set parameters based on site requirements.
- This function is applicable only to 1100 V and 1500 V inverters.

Because of permission restriction, log in as **Advanced User**. Choose **Monitoring > SUN2000 > Tracking System** to access the target page.

Figure 7-19 Setting a tracking system

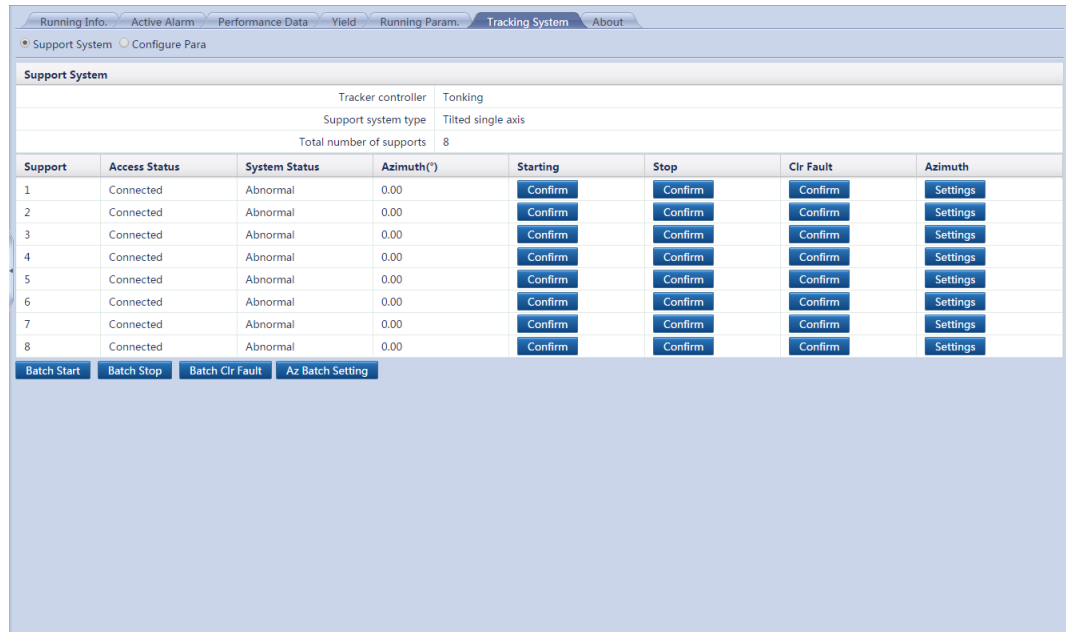

NOTE

You can click the Select icon in the upper left corner of the page to select a setting page.

7.9.2.5 Setting Characteristic Curves

Procedure

- Step 1** Log in as **Special User**, go to the **Characteristic Curve** page, set related parameters, and click **Submit**.

Figure 7-20 Characteristic Curve



IL02J00022

Characteristic Curve Name	Description
---------------------------	-------------

Characteristic Curve Name	Description
LVRT Characteristic Curve	Configure this characteristic curve based on the power grid standard. NOTE The SmartLogger supports only the 10-second LVRT characteristic curve configuration. If the power grid standard requires that the duration of LVRT be greater than 10s, LVRT Characteristic Curve is not displayed for the grid code.
[Voltage Rise Suppression]Q-U curve	<ol style="list-style-type: none"> 1. Set Voltage Rise Suppression to Enable. 2. Configure this characteristic curve based on the power grid standard.
[Voltage Rise Suppression]P-U curve	<ol style="list-style-type: none"> 1. Set Voltage Rise Suppression to Enable. 2. Configure this characteristic curve based on the power grid standard.

----End

7.9.3 SmartMBUS

The SmartLogger is integrated with the SmartMBUS and connected to the SUN2000 that supports the MBUS function over an AC power cable. Data is transmitted over the power cable to implement MBUS networking.

NOTE

After connecting the AC power cable to the SmartLogger, set **Built-in MBUS** to **Enable**. For details, see [7.12.8.1 Connecting Devices](#).

7.9.3.1 Querying Related Information

Choose **Monitoring > MBUS** and query related information on the displayed page.

Figure 7-21 Querying MBUS-related information

No.	Signal Name	Value	Unit
1	Device status	OnLine	
2	CCO net status	networking	
3	Device identification status	Idle	
4	AB/BC/CA line voltage	0.0/0.0/0.0	V
5	SNID	0	

NOTE

You can click the **Running Info.** or **About** tab on the tertiary navigation menu to query MBUS-related information.

7.9.3.2 Setting the STA List

Because of permission restriction, log in as **Advanced User**. Choose **Monitoring > MBUS > STA List** and set **Baud rate** for the listed devices on the displayed page.

NOTE

For a SmartLogger2000-10-C/11-C, you cannot set the baud rate or synchronize the baud rates of Huawei devices on this page.

Figure 7-22 Setting the STA list

No.	MAC Address	Device	SN	Comm Address	Baud rate
Number of online STAs: 0					

Export STA List

NOTE

- The STA list displays information about the inverter equipped with the MBUS STA module that is being connected.
- When changing the name of the exported file after the STA list is exported, retain the extension **.tar.gz**. Otherwise, the file will be unusable.

7.9.3.3 Networking Settings

Because of permission restriction, log in as **Advanced User**. Choose **Monitoring > MBUS > Networking Settings**.

Running parameters

Figure 7-23 Running parameters

<input type="checkbox"/> All	No.	Signal Name	Value	Unit
<input type="checkbox"/>	1	Baud rate	115200	
<input type="checkbox"/>	2	Anti-crosstalk	Enable	
<input type="checkbox"/>	3	Network frequency band	2.5-5.7 (MHz)	
<input type="checkbox"/>	4	Box-type transformer No.	10	(0-511)
<input type="checkbox"/>	5	Winding No.	2	(0-7)
<input type="checkbox"/>	6	Networking	Enable	

Submit

NOTE

- **Baud rate** is set to **115200** by default, which provides optimal communications performance and does not need to be changed.
- If **Anti-crosstalk** is set to **Enable**, the inverter with a MBUS STA in the SN list can access networking.
- Parameters **Box-type transformer No.** and **Winding No.** can be set for the SmartMBUS with SUN2000 V100R001C72SPC100 or later versions. In multi-split transformer scenarios, specify **Winding No.** based on the actual winding number of the SmartLogger connected to the transformer. When the box-type transformer and winding numbers of the inverter with an STA are consistent with those of the SmartMBUS, the inverter can access networking.
- When the SmartMBUS is SUN2000 V100R001C72SPC104 or later versions, you can set **Networking**. When the SmartLogger communicates with the inverter over MBUS, set **Networking** to **Enable** (default value). When the SmartLogger communicates with the inverter only over RS485, set **Networking** to **Disable**.

SN List

Figure 7-24 SN list

No.	SN	Match Status	Transformer No.	Winding No.	Device	Comm Address
1	024LURBTHA001296	●	13	6	33KTL(COM3-1)	1
2	024LURBTHA001364	●	13	6	33KTL(COM3-3)	3

NOTE

- The SN list displays the relevant information of the inverters with MBUS STAs that can be connected.
- Tap **Synchronize**, and synchronize the box-type transformer and winding numbers of the SmartMBUS to the inverter.

7.9.4 EMI

7.9.4.1 Querying Related Information

Choose **Monitoring > EMI** and query related information on the displayed page.

Figure 7-25 Querying EMI-related information

No.	Signal Name	Value	Unit
1	Daily irradiation amount	NA	kWh/m ²
2	Daily irradiation amount 2	NA	kWh/m ²
3	Total irradiance	NA	W/m ²
4	Total irradiance 2	NA	W/m ²
5	PV module temperature	NA	degC
6	Ambient temperature	NA	degC
7	Wind speed	NA	m/s
8	Wind direction	NA	
9	Custom 1	NA	
10	Custom 2	NA	

NOTE

- You can click the **Running Info.**, **Performance Data**, or **About** tab on the tertiary navigation menu to query EMI-related information.

- EMI performance data can be stored for three months and exported. When changing the name of the exported file, retain the extension **.tar.gz**. Otherwise, the file may be unavailable.
- When the SmartLogger connects to multiple EMIs and a master EMI is set, the **Performance Data** page displays the data about the master EMI. When the SmartLogger connects to multiple EMIs and no master EMI is set, the **Performance Data** page displays the data about any EMI.

7.9.4.2 Setting Modbus-RTU EMI Parameters

Step 1 Log in as **Advanced User** or **Special User**, set access parameters, and click **Add Devices**.

Figure 7-26 Setting access parameters

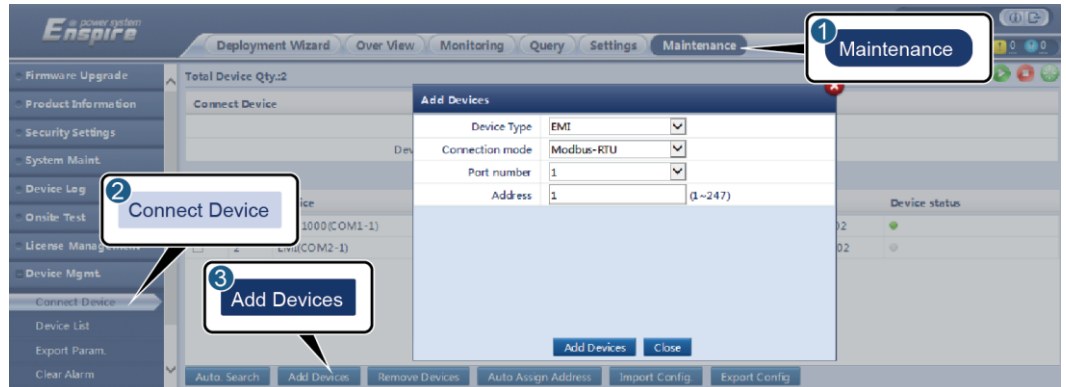

IL03J00023

Parameter	Description
Device Type	Set this parameter to EMI .
Connection mode	Set this parameter to Modbus-RTU .
Port number	Set this parameter to the serial number of the COM port connected to the EMI.
Address	Set this parameter to the communication address of the EMI.

Step 2 Log in as **Advanced User**, set running parameters and click **Submit**.

Figure 7-27 Setting running parameters

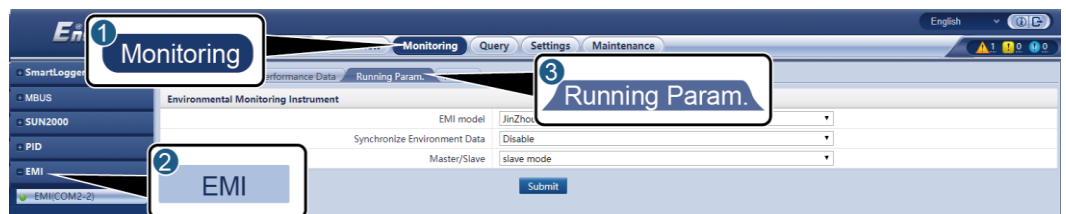

IL02J00017

- When the model of the connected device is in the **EMI model** drop-down list, set the parameters as follows.

Parameter	Description
EMI model	Set this parameter to the model of the corresponding EMI. Currently, the following models are supported: ABB VSN800-12, ABB VSN800-14, Gill MetPak Pro, Hukseflux SRx, Ingenieurbüro Si-RS485TC, Kipp&Zonen SMPx, Lufft WSx-UMB, Lufft WSx-UMB (external sensors), Meier-NT ADL-SR, Meteo control SR20-D2, Rainwise PVmet-150, Rainwise PVmet-200, Soluzione Solare SunMeter, JinZhou LiCheng, JinZhou YangGuang (PC-4), and HanDan (RYQ-3).
Synchronize Environment Data	Retain the default value Disable . NOTE If Enable is selected, wind speed and direction will be sent to the inverters in a PV plant with the tracking system.
Master/Slave	When the SmartLogger connects to multiple EMIs, you can set one of them to master mode . The inverter performance data contains that of the EMI in master mode .

- If the connected EMI is a split-type one that supports the Modbus-RTU protocol or of other models, set the parameters as follows.

Parameter	Description
EMI model	<ul style="list-style-type: none"> • If the connected EMI is a split-type one that supports the Modbus-RTU protocol, set this parameter to Sensor(ADAM). • If the connected EMI is of another model, set this parameter to Other.
Synchronize Environment Data	Retain the default value Disable . NOTE If Enable is selected, wind speed and direction will be sent to the inverters in a PV plant with the tracking system.
Master/Slave	When the SmartLogger connects to multiple EMIs, you can set one of them to master mode . The inverter performance data contains that of the EMI in master mode .
Read function code	Read holding register 03H and Read input register 04H are supported. Set this parameter based on the vendor's protocol.
Data reporting mode	Integer and Floating point are supported. Set this parameter based on the vendor's protocol.
Word ordering	Big endian and Little endian are supported. Set this parameter based on the vendor's protocol.
Read mode	Multiple read and Single read are supported.
Start address	When Read mode is set to Multiple read , set the start address.

Parameter	Description
End address	When Read mode is set to Multiple read , set the end address.
Signal NOTE Signal-related parameters include Signal Name, Signal address, Lower Thres., Upper Thres., Spec, Start (mV/mA), and End (mV/mA).	NOTE If the EMI can collect a certain signal, set Signal address to the address of the corresponding register. If not, set Signal address to 65535 .

----End

7.9.4.3 Setting AI EMI Parameters

Step 1 Log in as **Advanced User** or **Special User**, set access parameters, and click **Add Devices**.

Figure 7-28 Setting access parameters

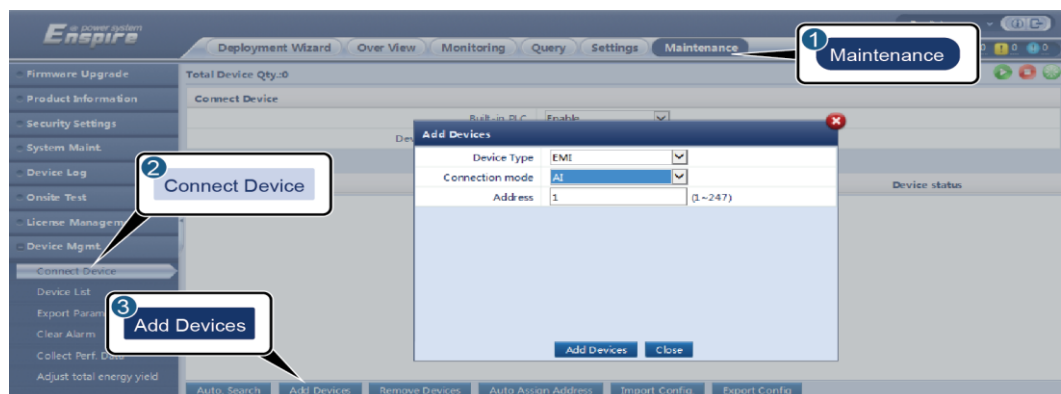

IL03J00025

Parameter	Description
Device Type	Set this parameter to EMI .
Connection mode	Set this parameter to AI .
Address	Set this parameter to the communication address of the EMI.

Step 2 Log in as **Advanced User** set running parameters, and click **Submit**.

Figure 7-29 Setting running parameters

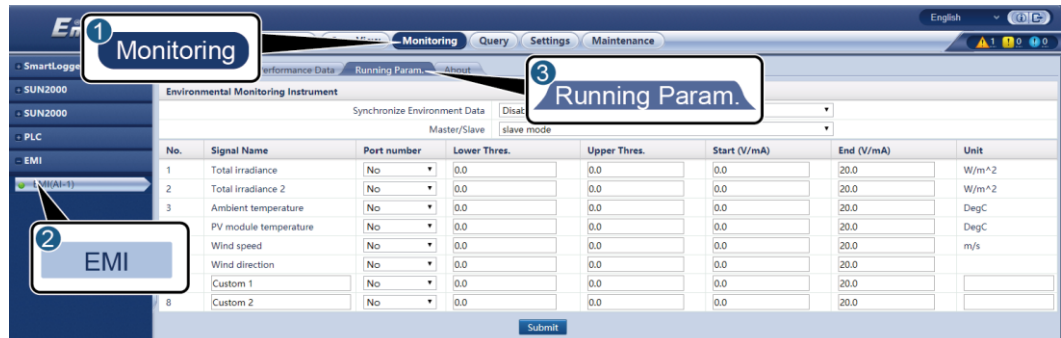

IL02J00018

Parameter	Description
Synchronize Environment Data	Retain the default value Disable . NOTE If Enable is selected, wind speed and direction will be sent to the inverters in a PV plant with the tracking system.
Master/Slave	When the SmartLogger connects to multiple EMIs, you can set one of them to master mode . The inverter performance data contains that of the EMI in master mode .
Signal parameters NOTE Signal parameters include Signal Name, Port number, Lower Thres., Upper Thres., Start (V/mA), End (V/mA), and Unit.	NOTE When you need to change the configured port number, set Port number to No first, then to the required port number.

----End

7.9.4.4 PT Temperature Correction

If the temperature detected by the PT100/PT1000 is different from the actual temperature, correct the PT temperature on the WebUI.

NOTICE

Before setting this parameter, ensure that:

1. The PT100/PT1000 has been connected. For details, see [Connecting to a PT100/PT1000 Temperature Sensor over the PT Port](#) in [4.6.3 Connecting the SmartLogger to a Split EMI](#).
2. **Port number** of **PV module temperature**, **Ambient temperature**, **Custom 1**, or **Custom 2** on the **Running Param.** page has been set to the connected PT port. For details, see [7.9.4.3 Setting AI EMI Parameters](#).

Because of permission restriction, log in as **Advanced User**, and then choose **EMI(AI) > PT T Correction**.

Figure 7-30 PT temperature correction

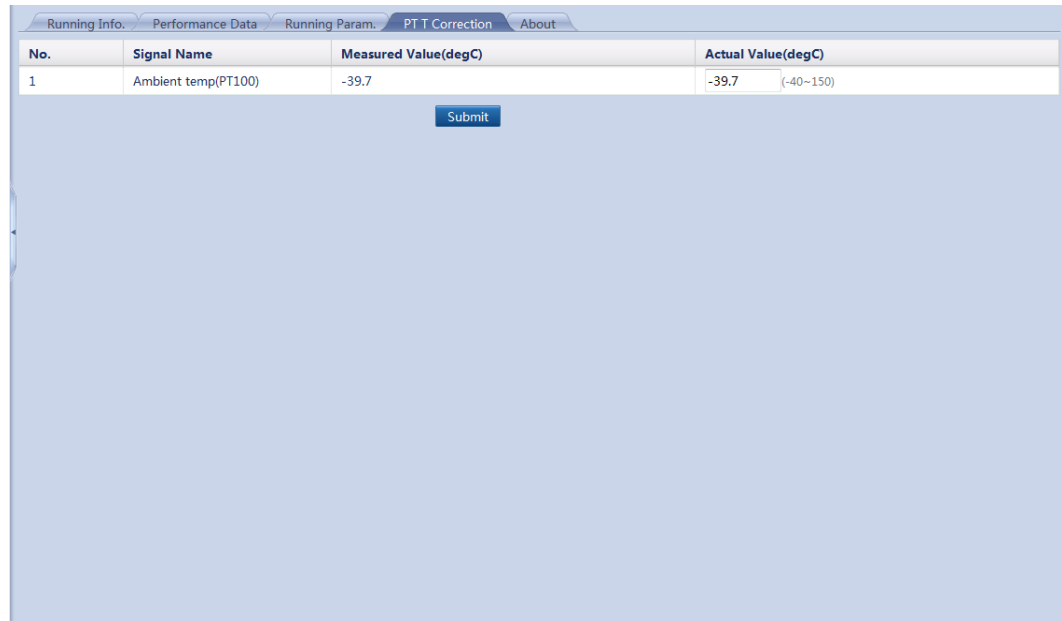

7.9.5 Power Meter

7.9.5.1 Querying Related Information

Choose **Monitoring > Meter** and query related information on the displayed page.

Figure 7-31 Querying the meter information

No.	Signal Name	Value	Unit
1	Device status	OnLine	
2	Line voltage between phases A and B	1004.00	V
3	Line voltage between phases B and C	1005.00	V
4	Line voltage between phases C and A	1006.00	V
5	Phase A voltage	1001.00	V
6	Phase B voltage	1002.00	V
7	Phase C voltage	1003.00	V
8	Phase A current	1007.0	A
9	Phase B current	1008.0	A
10	Phase C current	1009.0	A
11	Phase A active power	1016.000	kW
12	Phase B active power	1017.000	kW
13	Phase C active power	1018.000	kW
14	Active power	1010.000	kW
15	Reactive power	1011.000	kVar
16	Power factor	0.706	
17	Total active electricity	1019.00	kWh
18	Total reactive electricity	1020.00	kVarh
19	Total positive active electricity	1021.00	kWh
20	Total positive reactive electricity	1022.00	kVarh
21	Total negative active electricity	1023.00	kWh
22	Total negative reactive electricity	1024.00	kVarh

 **NOTE**

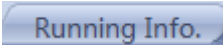
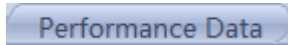
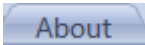
- You can click the , , or  tab on the tertiary navigation menu to query meter information.
- The performance data of the meter can be exported. When changing the name of the exported file, retain the extension **.tar.gz**. Otherwise, the file will be unusable.

7.9.5.2 Setting Running Parameters

Because of permission restriction, log in as **Advanced User**. Choose **Monitoring > Meter > Running Param.** to access the target page.

 **NOTE**

Set running parameters only for the power meter that supports the DL/T645 protocol.

Figure 7-32 Setting running parameters

<input type="checkbox"/> All	No.	Signal Name	Value	Unit
<input type="checkbox"/>	1	Protocol version	DL/T645-2007	
<input type="checkbox"/>	2	Number of lead bytes	4	(0-4)
<input type="checkbox"/>	3	Voltage change ratio	1.0	(0.1-2200.0)
<input type="checkbox"/>	4	Current change ratio	1.0	(0.1-2200.0)

7.9.6 PID

7.9.6.1 Querying Related Information

Choose **Monitoring > PID** and query related information on the displayed page.

 **NOTE**

This document describes the page displayed when the PID01 module is connected as an example.

Figure 7-33 Querying PID module-related Information

No.	Signal Name	Value	Unit
1	Device status	Disconnection	
2	Output voltage	NA	V
3	Output current	NA	mA
4	Cabinet temperature	NA	degC
5	PV1 voltage	NA	V
6	PV2 voltage	NA	V
7	Grid AB line voltage	NA	V
8	Grid BC line voltage	NA	V
9	Grid CA line voltage	NA	V
10	Grid frequency	NA	Hz
11	Power grid imbalance	NA	%
12	Voltage harmonic	NA	%

NOTE

- You can click the **Running Info.**, **Active Alarm**, **Performance Data**, or **About** tab on the tertiary navigation menu to query PID module-related information.
- Performance data of the PID module can be exported. When changing the name of the exported file, retain the extension **.tar.gz**. Otherwise, the file will be unavailable.

7.9.6.2 Setting Running Parameters

Because of permission restriction, log in as **Advanced User**. Choose **Monitoring > PID > Running Param.** to access the target page.

Figure 7-34 Setting running parameters

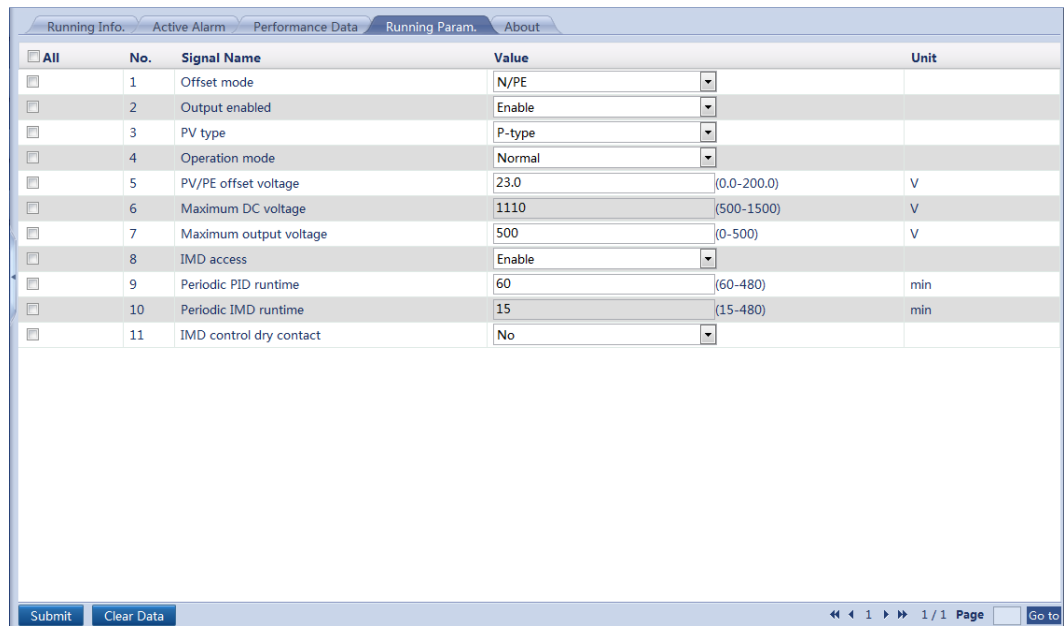

NOTE

The parameter list provided in this document includes all configurable parameters. Configurable parameters vary depending on the device model. The actual display prevails.

Table 7-12 Parameter description

No.	Parameter	Function	Value	Description
1	Offset mode	Specifies the offset mode of the PID module.	Disabled	Select Disabled if the PID module is not required.
			N/PE	<ul style="list-style-type: none"> PID01: Select N/PE if the PID module is required to use voltage output from the inductor virtual midpoint. SmartPID2000: Select N/PE if the PID module is required to use voltage output from the power grid.
			PV/PE	<ul style="list-style-type: none"> PID01: Select PV/PE if the PID module is required to use voltage output from the negative PV terminal. This mode is applicable only to Huawei SUN8000. SmartPID2000: N/A
			Automatic	<ul style="list-style-type: none"> PID01: For the inverter, Automatic indicates the N/PE offset mode. SmartPID2000: N/A
2	Output enabled	Specifies whether PID module output is enabled.	Enable	Select Enable to enable the PID module output.
			Disable	Select Disable to disable the PID module output.
3	PV type	Specifies the type of the PV module	P-type	Select this value if the PV module type is P. In this case, the PID module output voltage is positive.

No.	Parameter	Function	Value	Description
		used in the PV plant. For details about the PV module type, consult the manufacturer.	N-type	Select this value if the PV module type is N. In this case, the PID module output voltage is negative.
4	PV/PE offset voltage	Specifies the DC output voltage when the offset mode is set to PV/PE.	0–200 V	It is recommended that the offset voltage be set to a value ranging from 50 V to 200 V.
5	Operation Mode	Specifies whether the PID module is currently working in normal or commissioning mode.	Commissioning	In commissioning mode, if you need to set the output mode to PV/PE or N/PE , set Output enabled to Enable . The PID module delivers output voltages based on the value of Commissioning output voltage . NOTE To check whether the PID module functions properly, it is recommended that Operation mode be set to Commissioning upon first power-on.
			Normal	In normal mode, the PID module operates automatically after the PID module, inverter, and SmartLogger communicate with each other properly. NOTE After checking that the PID module functions properly, set Operation mode to Normal .
6	Commissioning output voltage	Specifies the output voltage when Operation Mode or Working mode is set to Commissioning .	PID01: 0–500 V	It is recommended that the commissioning voltage for the 1000 V/1100 V inverter be set to a value ranging from 50 V to 400 V.
			SmartPID 2000: 0–800 V	It is recommended that the commissioning output voltage for the 1000 V/1100 V inverter be set to a value ranging from 50 V to 400 V, and that the commissioning output voltage for the 1500 V inverter be set to a value ranging from 50 V to 600 V. NOTE After this parameter is set and the output from the PID module becomes stable, use a multimeter that is set to the DC position to measure the three-phase (A, B, and C) voltages of the power grid to the ground, and check whether the voltages are the same as the configured values.
7	Maximum DC voltage	Specifies the PV-PE voltage when the normal operation mode is used.	500–1500 V	If the PV module type is P, the parameter value indicates the highest DC voltage between PV+ and PE. If the PV module type is N, the parameter value indicates the highest DC voltage between PV– and PE.
8	Maximum output	Specifies the highest output voltage of the	PID01: 0–500 V	If the offset mode is PV/PE , the parameter value indicates the highest DC output voltage between PV and PE. If the offset mode is N/PE , the parameter value indicates the

No.	Parameter	Function	Value	Description
	voltage	PID module when Operation Mode or Working mode is set to Normal or Commissioning .	SmartPID 2000: 0–800 V	highest DC output voltage between N and PE. <ul style="list-style-type: none"> For the 1000 V/1100 V inverter, the value ranges from 0 V to 550 V. The parameter value indicates the maximum DC raise voltage between PV and ground. For the 1500 V inverter, the value ranges from 0 V to 800 V. The parameter value indicates the maximum DC raise voltage between PV and ground. The default value is 500 V. For the 1500 V inverter, the recommended value is 800 V.
9	IMD access	Specifies whether the PID module and insulation monitor device (IMD) can operate in cycle mode.	Enable	Select Enable if you allow the PID module and IMD operate in cycle mode. Only the IMDs of mainstream suppliers such as DOLD and BENDER are supported, and the IMDs must have enabled dry contacts. NOTICE Only when IMD access is set to Enable , can you set Periodic PID runtime , Periodic IMD runtime , and IMD control dry contact .
			Disable	Select Disable if you forbid the access of IMDs.
10	Periodic PID runtime	Specifies the operating time segment of the PID module when the PID module and IMD operate in cycle mode.	60–480 minutes	The IMD is shut down when the PID module is operating.
11	Periodic IMD runtime	Specifies the operating time segment of the IMD when the PID module and IMD operate in cycle mode.	15–480 minutes	The PID module is standby when the IMD is operating.
12	IMD control dry contact	Dry contact No. over which the SmartLogger controls the IMD	No, DO1, DO2, and DO3	<ul style="list-style-type: none"> PID01: Set appropriate ports based on the cable connections between the IMD and the SmartLogger. SmartPID2000: N/A
13	PV module compensation voltage direction	Specifies the offset direction of the PID module.	PV– positive offset	<ul style="list-style-type: none"> PV– positive offset refers to raising the voltage between PV– and the ground to above 0 V through voltage compensation. Select PV– positive offset for P-type PV modules or the N-type PV modules that comprise the solar cells whose positive and negative polarities are on different sides. For example, P-type PV modules, HIT, CIS, thin-film PV modules, and CdTe PV modules meet the
			PV+ negative offset	

No.	Parameter	Function	Value	Description
				<p>requirement for PV– positive offset.</p> <ul style="list-style-type: none"> PV+ negative offset refers to lowering the voltage between PV+ and ground to below 0 V through voltage compensation. <p>Select PV+ negative offset for the N-type PV modules that comprise the solar cells whose positive and negative polarities are on the same side.</p> <p>NOTE When designing a PV plant, the design institute or user should ask the PV module vendor about the direction of voltage compensation for resisting the PID effect.</p>
14	Working mode	Specifies the working mode of the PID module.	Normal	In normal mode, the PID module operates automatically after the PID module, inverter, and SmartLogger communicate with each other properly.
			Commissioning	In commissioning mode, set Commissioning output voltage . The PID module delivers voltage based on the commissioning output voltage.
				<p>NOTE To check whether the PID module functions properly, it is recommended that Working mode be set to Commissioning upon first power-on.</p>
15	Maximum system DC-to-ground withstand voltage	Specifies the voltages between the PV side and PE and between the AC side and ground in normal mode.	500–1500 V	<p>Specifies the lower thresholds of the maximum voltage ranges between the inverter DC side (including the inverter, PV module, cable, SPD, and switch) and ground in a PV power system.</p> <p>The default value is 1000 V. For the 1500 V inverter, the recommended value is 1500 V.</p>
16	AC-to-ground resistance alarm threshold	Specifies the alarm threshold for the impedance between the AC side of the PID module and ground.	0.2–100 kΩ	You can set an alarm threshold for the impedance between the AC grid and ground for the PID module. If the detected impedance is below the threshold, the PID module will generate an alarm.
17	Compensation offset voltage	Specifies the compensation offset voltage between PV and PE after the PID module operates stably.	0–500 V	<p>The value ranges from 0–500 V, and the default value is 50 V.</p> <ul style="list-style-type: none"> If the PV module compensation voltage direction is set to PV– positive offset, the value indicates the positive voltage between PV– and the ground, and the compensation range is 0–500 V. If PV module compensation voltage direction is set to PV+ negative offset, the value indicates the negative voltage between PV+ and ground, and the compensation –500 V to 0 V. <p>NOTE <ul style="list-style-type: none"> If Compensation offset voltage is set to 500 V, the PID </p>

No.	Parameter	Function	Value	Description
				<p>module provides the maximum output to enhance the voltage compensation effect. The output voltage amplitude of the PID module is automatically capped to ensure the safety of a PV power plant. The output voltage amplitude is also related to the maximum system DC-to-ground withstand voltage and maximum output voltage.</p> <ul style="list-style-type: none"> After this parameter is set and the PID module works properly, use a multimeter that is set to the DC position to measure the voltage between the PV input terminal of the SUN2000 and ground. (For PV- positive offset, check whether the voltage between PV- and ground is greater than or equal to 0 V. For PV+ negative offset, check whether the voltage between PV+ and ground is equal to or less than 0 V.)
18	Clear Data	Clears the active alarms and historical alarms stored on the PID module.	N/A	You can select Clear Data to clear active alarms and historical alarms for the PID module.

7.9.7 PID-PVBOX

7.9.7.1 Querying Related Information

Choose **Monitoring** > **PID-PVBOX** and query related information on the displayed page.

Figure 7-35 Querying PID-PVBOX-related information

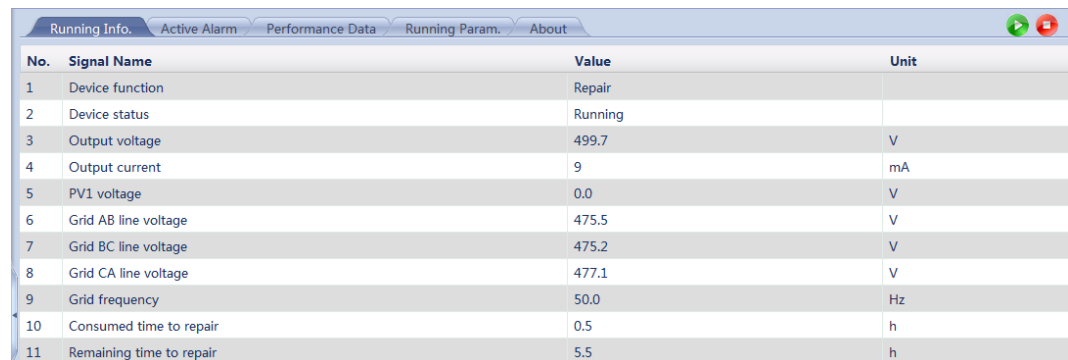

No.	Signal Name	Value	Unit
1	Device function	Repair	
2	Device status	Running	
3	Output voltage	499.7	V
4	Output current	9	mA
5	PV1 voltage	0.0	V
6	Grid AB line voltage	475.5	V
7	Grid BC line voltage	475.2	V
8	Grid CA line voltage	477.1	V
9	Grid frequency	50.0	Hz
10	Consumed time to repair	0.5	h
11	Remaining time to repair	5.5	h

NOTE

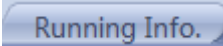
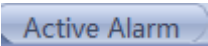
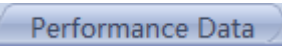
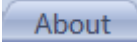
- You can click the , , , or  tab on the tertiary navigation tree to query related information.
- The **Performance Data** of the PID-PVBOX can be exported. When changing the name of the exported file, retain the extension **.tar.gz**. Otherwise, the file will be unavailable.

7.9.7.2 Setting Running Parameters

Because of permission restriction, log in as **Advanced user**. Choose **Monitoring > PID-PVBOX > Running Param.** to enter the target page.

Figure 7-36 Setting running parameters

<input type="checkbox"/> All	No.	Signal Name	Value	Unit
<input type="checkbox"/>	1	Operation mode	Commissioning	
<input type="checkbox"/>	2	Commissioning output voltage	0.0 (0.0-100.0)	V
<input type="checkbox"/>	3	Repair time	6.0 (0.0-6.0)	h
<input type="checkbox"/>	4	Voltage to be repaired	500 (50-500)	V

Parameter	Description
Operation mode	<p>Specifies the current working mode of the PID module.</p> <ul style="list-style-type: none"> Before setting this parameter to Commissioning, ensure that inverters in a PV array are powered off and their DC switches are turned off. This working mode is used during commissioning after deployment or fault locating. In this case, the PID-PVBOX delivers the output voltage based on the value of the commissioned output voltage. Set this parameter to Normal after ensuring that the PID module works normally.
Commissioning output voltage	Specifies the output voltage when the PID module works in commissioning mode.
Repair time	Set the recovery time for each day.
Voltage to be repaired	Specifies the output voltage when the PID module works in normal mode.

7.9.8 PID-SSC

7.9.8.1 Querying Related Information

Choose **Monitoring > PID-SSC** and query related information on the displayed page.

Figure 7-37 Querying PID-SSC-related information

No.	Signal Name	Value	Unit
1	Device function	Power	
2	Device status	Idle	
3	Output voltage	0.0	V
4	Output current	0	mA
5	Grid AB line voltage	521.5	V
6	Grid BC line voltage	524.3	V
7	Grid CA line voltage	525.6	V
8	Grid frequency	49.9	Hz

NOTE

- You can click the **Running Info.**, **Active Alarm**, **Performance Data**, or **About** tab on the tertiary navigation tree to query related information.
- The **Performance Data** of the PID-SSC can be exported. When changing the name of the exported file, retain the extension **.tar.gz**. Otherwise, the file will be unavailable.

7.9.8.2 Setting Running Parameters

Because of permission restriction, log in as **Advanced user**. Choose **Monitoring > PID-SSC > Running Param.** to enter the target page.

Figure 7-38 Setting running parameters

<input type="checkbox"/> All	No.	Signal Name	Value	Unit
<input type="checkbox"/>	1	Operation mode	Commissioning	
<input type="checkbox"/>	2	Commissioning output voltage	0.0 (0.0-500.0)	V

Parameter	Description
Operation mode	Specifies the current working mode of the PID module. <ul style="list-style-type: none"> Set this parameter to Commissioning during commissioning after deployment or fault locating. In this case, the PID-SSC delivers the output voltage based on the value of the commissioned output voltage. Set this parameter to Normal after ensuring that the PID module works normally.
Commissioning output voltage	Specifies the output voltage when the PID module works in commissioning mode. It is recommended that Commissioning output voltage be set to a value greater than 250 V.

7.9.9 Smart Transformer Station (STS)



7.9.9.1 Querying Related Information

Choose **Monitoring** > **STS** and query related information on the displayed page.

Figure 7-39 Querying STS-related information

No.	Signal Name	Value	Unit
1	Transformer heavy gas	1	
2	Transformer light gas	0	
3	Transformer pressure valve action	1	
4	Transformer low oil level	0	
5	Transformer high oil level	1	
6	Transformer high oil temperature	0	
7	Transformer ultra-high oil temperature	1	
8	11111	0	
9	Low-voltage cabinet A ACB ON	1	
10	Low-voltage cabinet A ACB OFF	0	
11	Low-voltage cabinet A ACB fault tripping	1	
12	Low-voltage cabinet A ACB remote operation	0	
13	Low-voltage cabinet B ACB ON	1	
14	Low-voltage cabinet B ACB OFF	0	
15	Low-voltage cabinet B ACB fault tripping	1	
16	Low-voltage cabinet B ACB remote operation	0	
17	Low-voltage cabinet A temperature control system fault	1	
18	Low-voltage cabinet B temperature control system fault	1	
19	Low-voltage room smoke alarm	1	
20	Transformer cabinet G2 circuit breaker ON	1	
21	Transformer cabinet G2 circuit breaker OFF	1	

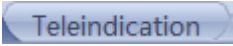
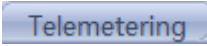
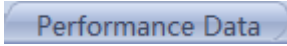
NOTE

- You can click the , , , or  tab on the tertiary navigation tree to query related information.
- The STS **Performance Data** can be exported. When changing the name of the exported file, retain the extension **.tar.gz**. Otherwise, the file will be unavailable.

7.9.9.2 Setting STS Parameters

Telecontrol

- Log in as **Advanced User** because of permission restrictions. Choose **Monitoring** > **STS** > **Telecontrol**.
- Select the corresponding signal name and click **Submit** to turn on or off a circuit breaker.

NOTE

ON and OFF signals of circuit breakers cannot be submitted at the same time. For example: No.1 (**Low-voltage cabinet A frame circuit breaker remote ON**) and No.2 (**Low-voltage cabinet A frame circuit breaker remote OFF**) cannot be submitted at the same time.

Running Param.

Log in as **Advanced User** because of permission restrictions. Choose **Monitoring > STS > Running Param.** and add the names of standby teleindication, telemetering, and telecontrol signals.

Table 7-13 Running Param.

Parameter	Description
Teleindication	Select the position of the standby signal based on Register Address and Bit , enter the signal name, select Display , and click Submit .
Telemetering	Select the position of the standby signal based on Register Address , enter the signal name, select Display , set Gain and Unit , and click Submit .
Telecontrol	Select the position of the standby signal based on Register Address , enter the signal name, select Display , and click Submit .

7.9.10 Custom Device, IEC103 Device, or IEC104 Device

Custom Device: The SmartLogger can connect to the third-party devices supporting the Modbus-RTU protocol, such as the box-type transformer and environmental monitoring instrument (EMI). Since the protocol information points vary depending on vendors, you need to obtain a protocol information file in **.cfg** format from Huawei and import the file into the SmartLogger for successfully connecting to a third-party device.

IEC103 Device: The SmartLogger can connect to the third-party devices supporting IEC103, such as the relay protection or monitoring device like the box-type transformer. Since the protocol information points vary depending on vendors, you need to obtain a protocol information file in **.cfg** format from Huawei and import the file into the SmartLogger for successfully connecting to a third-party device.

IEC104 Device: The SmartLogger can connect to the third-party devices supporting IEC104, such as the relay protection or monitoring device like the box-type transformer. Since the protocol information points vary depending on vendors, you need to obtain a protocol information file in **.cfg** format from Huawei and import the file into the SmartLogger for successfully connecting to a third-party device.

NOTE

- Custom, IEC103, or IEC104 devices cannot be detected automatically and need to be added manually. For details, see [7.12.8.1 Connecting Devices](#).
- A maximum of 10 types of custom devices and five types of IEC103 and IEC104 devices can be connected. Each type supports more than one device.

7.9.10.1 Querying Related Information

Select a device on the **Monitoring** page and query related information on the displayed page.

Figure 7-40 Querying device information

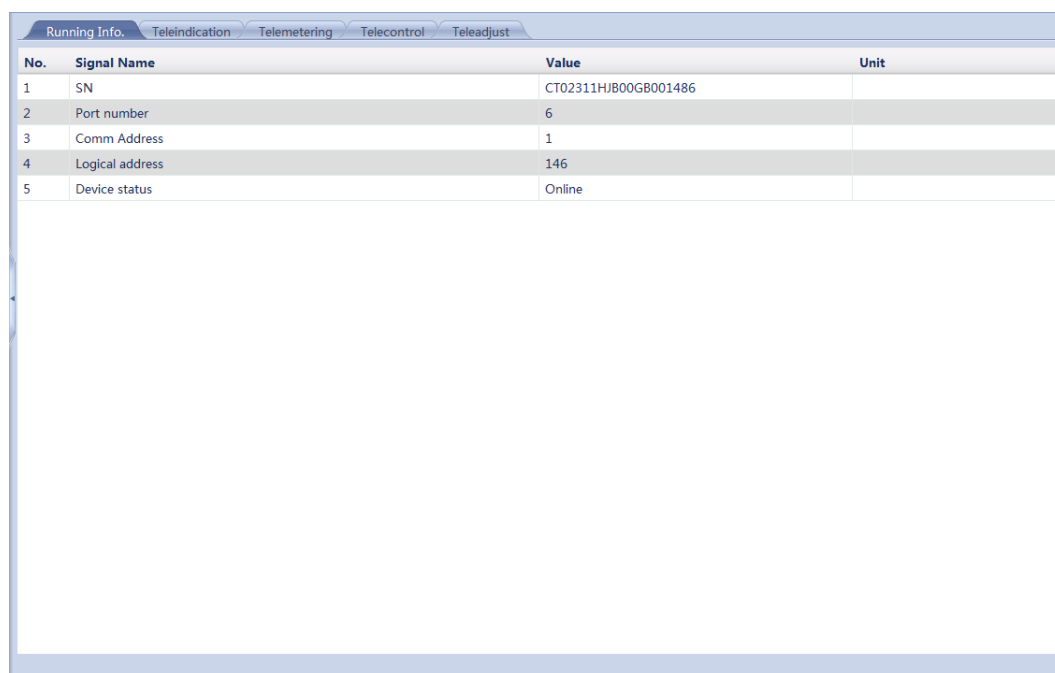

No.	Signal Name	Value	Unit
1	SN	CT02311HJB00GB001486	
2	Port number	6	
3	Comm Address	1	
4	Logical address	146	
5	Device status	Online	

NOTE

Click the **Running Info.**, **Teleindication**, or **Telemetry** tab on the tertiary navigation menu to query device information.

7.9.10.2 Setting Telecontrol Parameters

Select a device on the **Monitoring** page, and select **Telecontrol** to go to the page.

Figure 7-41 Setting Telecontrol Parameters

<input type="checkbox"/> All	No.	Signal Name	Value	Unit
<input type="checkbox"/>	1	Power-On	<input type="text" value="0"/>	
<input type="checkbox"/>	2	Power-Off	<input type="text" value="0"/>	

7.9.10.3 Setting Teleadjust Parameters

Select a device on the **Monitoring** page, and select **Teleadjust** to go to the page.

Figure 7-42 Setting Teleadjust Parameters

<input type="checkbox"/> All	No.	Signal Name	Value	Unit
<input type="checkbox"/>	1	Protec. OV niveau-1	<input type="text" value="0"/>	
<input type="checkbox"/>	2	Durée protec. OV niv.1	<input type="text" value="0"/>	

7.10 Querying Historical Data

7.10.1 Querying Historical Alarms

Choose **Query > Alarm History** and query alarms on the displayed page.

Figure 7-43 Historical alarms

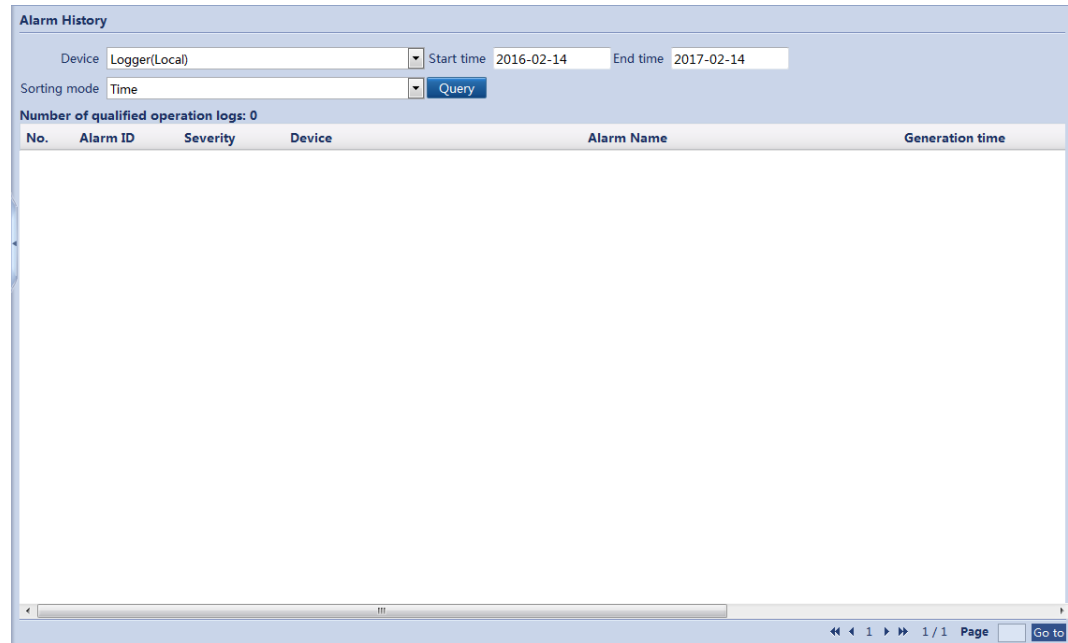

7.10.2 Querying Operation Logs

Because of permission restriction, log in as **Advanced User** or **Special User**. Choose **Query > Operation Log** and query logs on the displayed page.

Figure 7-44 Operation log

Operation Log				
Number of qualified operation logs: 474				
No.	User Name	Operation Time	Operation Source	Content
1	Advanced User	2019-03-01 17:11:00	WEB	Logger(Local)-End address->247
2	Advanced User	2019-03-01 17:11:00	WEB	Logger(Local)-Start address->1
3	Advanced User	2019-03-01 17:11:00	WEB	Logger(Local)-Stop bit->1
4	Advanced User	2019-03-01 17:11:00	WEB	Logger(Local)-Parity->None
5	Advanced User	2019-03-01 17:11:00	WEB	Logger(Local)-Baud rate->115200
6	Advanced User	2019-03-01 17:11:00	WEB	Logger(Local)-Protocol->Modbus
7	Advanced User	2019-03-01 17:11:00	WEB	Logger(Local)-End address->247
8	Advanced User	2019-03-01 17:11:00	WEB	Logger(Local)-Start address->1
9	Advanced User	2019-03-01 17:11:00	WEB	Logger(Local)-Stop bit->1
10	Advanced User	2019-03-01 17:10:59	WEB	Logger(Local)-Parity->None
11	Advanced User	2019-03-01 17:10:59	WEB	Logger(Local)-Baud rate->115200
12	Advanced User	2019-03-01 17:10:59	WEB	Logger(Local)-Protocol->Modbus
13	Advanced User	2019-03-01 17:10:59	WEB	Logger(Local)-End address->150
14	Advanced User	2019-03-01 17:10:59	WEB	Logger(Local)-Start address->1
15	Advanced User	2019-03-01 17:10:59	WEB	Logger(Local)-Stop bit->1
16	Advanced User	2019-03-01 17:10:59	WEB	Logger(Local)-Parity->None
17	Advanced User	2019-03-01 17:10:59	WEB	Logger(Local)-Baud rate->115200
18	Advanced User	2019-03-01 17:10:59	WEB	Logger(Local)-Protocol->Modbus
19	Advanced User	2019-03-01 17:10:45	WEB	Logger(Local)-End address->247
20	Advanced User	2019-03-01 17:10:45	WEB	Logger(Local)-Start address->1

7.10.3 Exporting Data

Because of permission restriction, log in as **Advanced User** or **Special User**. Choose **Query > Export Data** and export data on the displayed page.

Figure 7-45 Exporting data

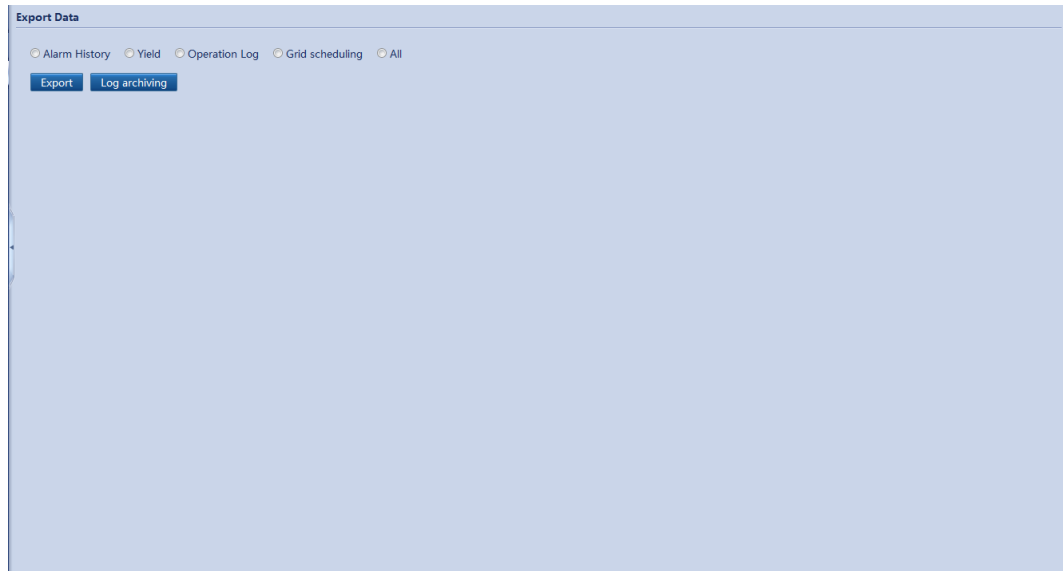

NOTE

When changing the name of the exported file, do not change the file name extension. Otherwise, the file may be unavailable.

Opening the Exported File

The exported file is in CSV format and can be opened in Excel. After opening the file in Excel, the cells may not be neatly organized. Set **List separator** to ,.

To view and change the list separator, perform the following steps:

1. Open **Control Panel** and choose **Region and Language**.
2. Under **Formats**, click **Additional settings**.

Figure 7-46 Viewing and changing the list separator (1)

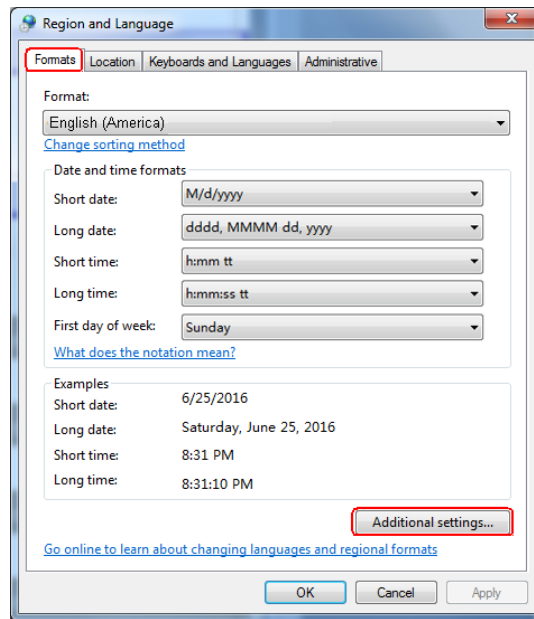

3. View and change the list separator.
 - If **List separator** is ,, click **OK**.
 - If **List separator** is not ,, change it to ,, and click **OK**.

Figure 7-47 Viewing and changing the list separator (2)

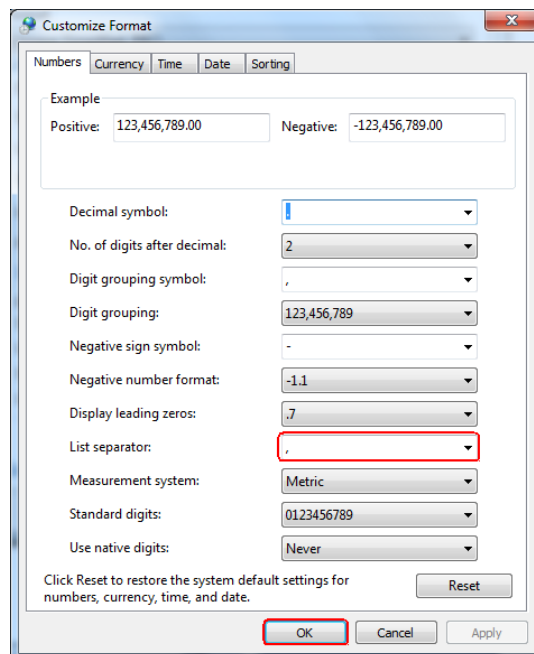

7.11 Settings

7.11.1 User Parameters

7.11.1.1 Setting the Date and Time

Because of permission restriction, log in as **Common User** or **Advanced User**. Choose **Settings > Date&Time** to access the target page.

Figure 7-48 Setting the date and time

Date	
Local time zone	(UTC+08:00)Beijing
Date	2018-09-21 (YYYY-MM-DD)
Time	10:16:21 (HH:MM:SS)
Clock source	Management System
Synchronization server	NA
Latest synchronization time	2018-09-21 10:10:55

NOTICE

- The **Local time zone** parameter is unavailable for zones without DST.
- After **Date&Time** is set, the date and time of all the inverters connected to SmartLogger are updated accordingly. Ensure that the settings are correct.
- Modification of **Date&Time** may affect the recording of energy yield and performance data. Therefore, do not change the time zone or system time arbitrarily.

7.11.1.2 Setting Plant Information

After you set plant information, a plant configuration file can be generated. You can upload this file to a third-party hosting website to implement remote monitoring.

Because of permission restriction, log in as **Common User** or **Advanced User**. Choose **Settings > Plant** to access the target page.

Figure 7-49 Setting plant information

Plant Info.	
Plant name	<input type="text"/>
Plant address	<input type="text"/>
Plant owner	<input type="text"/>
Plant owner address	<input type="text"/>
Country	CN(China, People's Republic of) <input type="button" value="v"/>

 **NOTE**

When setting plant information, you cannot successfully enter any character such as <>,:;'?()#&\\$|%+;~^" in the English half-width status.

7.11.1.3 Setting Gain Parameters

Because of permission restriction, log in as **Common User** or **Advanced User**. Choose **Settings > Revenue** to access the target page.

Figure 7-50 Setting gain parameters

Gain Parameters	
Currency	EUR
Electricity price/kWh	10.000 (0.000~999.999)
CO2 emission reduction coefficient	10.000 kg/kWh (0.000~10.000)

Submit

 **NOTE**

Electricity price/kWh indicates the local power price, and is used to calculate the translation gain of the energy yield.

7.11.1.4 Setting the Save Period

Because of permission restriction, log in as **Common User** or **Advanced User**. Choose **Settings > Save Period**, and set the save period of the performance data.

After the setting, the data will be displayed accordingly on the **Performance Data** page.

Figure 7-51 Setting the save period

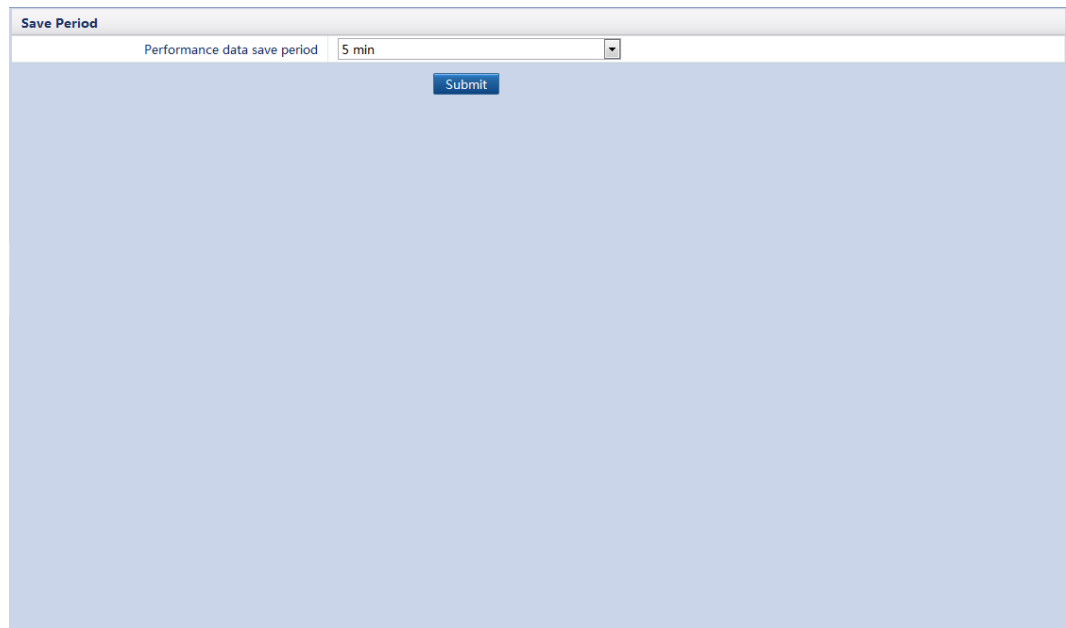

7.11.1.5 Setting the Name of the Built-in Bluetooth Module

The name of the SmartLogger built-in Bluetooth module is **LOG + the last eight figures of the SN of the SmartLogger** by default. Users can change the name over the WebUI.

NOTE

The SmartLogger2000-10, however, does not support the name change.

Because of permission restriction, log in as **Advanced User**. Choose **Settings > Bluetooth**.

Figure 7-52 Setting the name of the built-in Bluetooth module

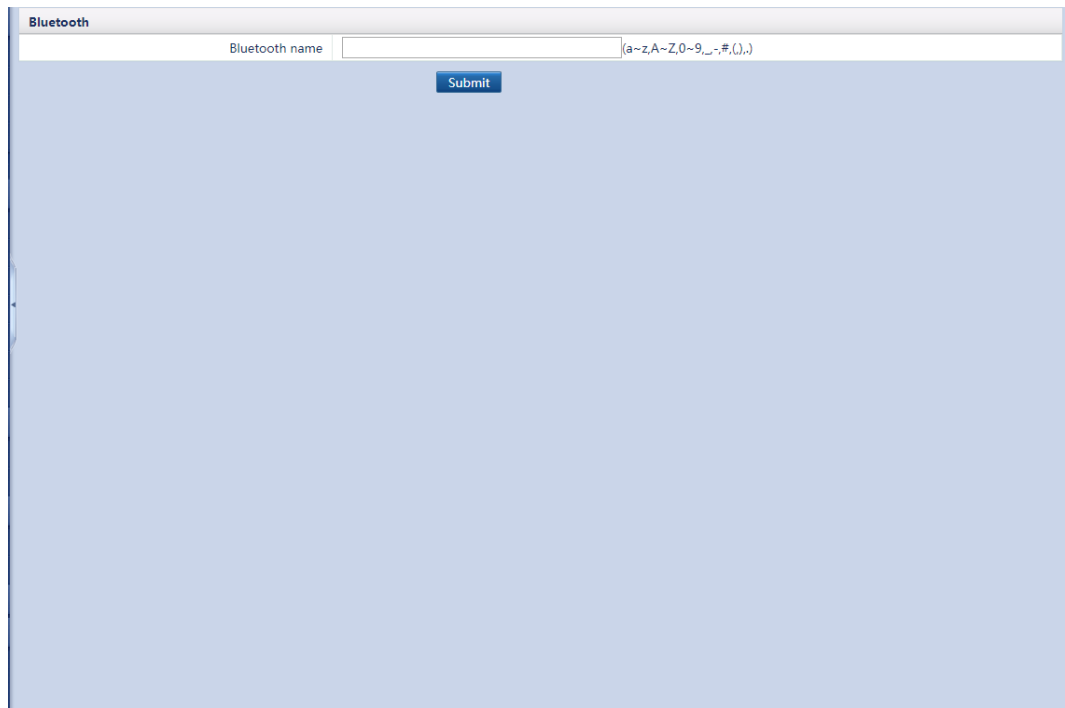

The screenshot shows a web interface for configuring Bluetooth settings. At the top, there is a header bar with the title 'Bluetooth'. Below the header, there is a text input field labeled 'Bluetooth name' with a placeholder '(a-z,A-Z,0-9,-,_,#,(,))'. Below the input field is a blue 'Submit' button.

7.11.2 Communications Parameters

7.11.2.1 Setting Wired Network Parameters

Because of permission restriction, log in as **Advanced User**. Choose **Settings > Wired Network** to access the target page.

Figure 7-53 Setting wired network parameters

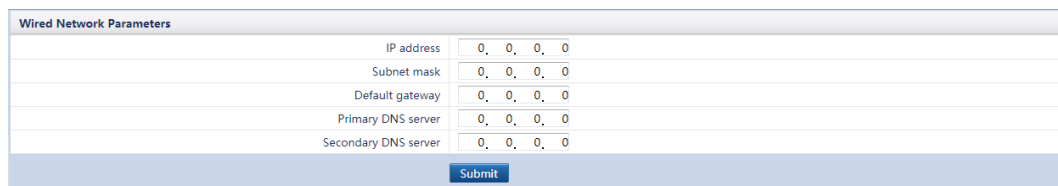

The screenshot shows a web interface for configuring wired network parameters. The page title is 'Wired Network Parameters'. It contains five rows of input fields for 'IP address', 'Subnet mask', 'Default gateway', 'Primary DNS server', and 'Secondary DNS server', each with a default value of '0, 0, 0, 0'. A blue 'Submit' button is located at the bottom right.

NOTICE

If the SmartLogger connects to the Internet through a router, note the following when setting wired network parameters:

- Set the gateway address to the IP address of the router.
- Ensure that the IP address of the SmartLogger is in the same network segment as the gateway address.
- Set the domain name server (DNS) address to the IP address of the router or obtain the DNS address from the network provider.

NOTE

If the IP address is changed, you need to use the new IP address to log in to the system.

7.11.2.2 Setting RS485 Parameters

Because of permission restriction, log in as **Advanced User** or **Special User**. Choose **Settings > RS485** to access the target page.

Figure 7-54 RS485 parameters

RS485	Protocol	Baud rate	Parity	Stop Bit	Start address	End address
RS485-1	Modbus	9600	None	1	1 (1-247)	247 (1-247)
RS485-2	Modbus	9600	None	1	1 (1-247)	247 (1-247)
RS485-3	Modbus	9600	None	1	1 (1-247)	247 (1-247)
RS485-4	Modbus	9600	None	1	1 (1-247)	247 (1-247)
RS485-5	Modbus	9600	None	1	1 (1-247)	247 (1-247)
RS485-6	Modbus	9600	None	1	1 (1-247)	247 (1-247)

Night Comm. Settings

Records

NOTE

- **RS485-1** to **RS485-6** respectively correspond to communications ports **COM1–COM6**, and the baud rate is 9600 bit/s by default. The baud rates for devices connected to the same RS485 port must be the same.
- Set the protocol supported by the RS485 port based on either the protocol supported by the connected device or the status of the device in the network. When the SmartLogger serves as a slave node to interconnect with a third-party device over Modbus-RTU, set **Protocol** to **Modbus-Slave**. When the connected inverter performs rapid power grid scheduling using both MBUS (PLC) and RS485, set **Protocol** to **Modbus-Control**.
- **Protocol**, **Parity**, and **Stop Bit** must be set to the same values for all devices connected to the same RS485 port.
- $1 \leq \text{start address} \leq \text{end address} \leq 247$. The address segments for each RS485 port from **RS485-1** to **RS485-6** can overlap.

Set the address range as required. A larger address range requires a longer searching time. The start and end addresses have no impact on the devices that have been connected.

7.11.2.3 Setting Power Meter Parameters

Log in as **Advanced User** or **Special User**, set power meter parameters, and click **Submit**.

Figure 7-55 Setting power meter parameters

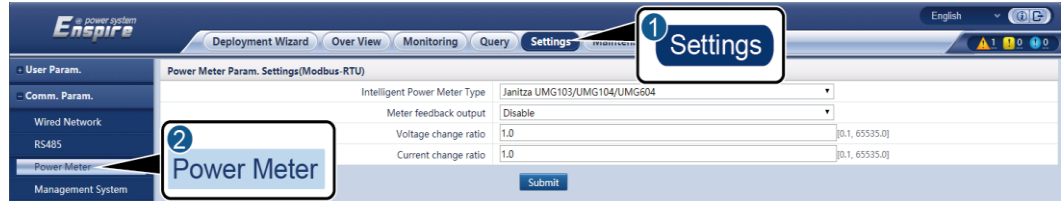

IL02J00016

- When the model of the connected power meter is in the **Intelligent Power Meter Type** drop-down list box, set the parameters as follows.

Parameter	Description
Intelligent Power Meter Type	Set this parameter to the corresponding meter model. Currently, the following meter models are supported: ABB A44, Acrel PZ96L, algodue UPM209, CHNT DTSU666, CHNT DTSU666-H, Elster A1800ALPHA, Janitza UMG103/UMG104/UMG604, Lead LD-C83, MingHua CRDM-830, Mitsubishi LMS-0441E, NARUN PD510, NetBiter CEWE, People RM858E, Schneider PM1200, SFERE PD194Z, Socomec COUNTIS E43, and Toshiba S2MS.
Meter feedback output	Set this parameter based on whether the power meter needs to report the data of the grid-tied point.
Voltage change ratio	<ul style="list-style-type: none"> • Set this parameter to 1 when the power meter uploads the primary value. • Set this parameter based on the actual transformer ratio when the power meter uploads the secondary value.
Current change ratio	
Feedback Parameter	Set this parameter based on the parameter name to be reported.
Start Current (mA)	Indicates the valid value range of signals carried by the analog output loop. The current range is less than or equal to the current range specified in the AO specifications. Start Data corresponds to End Data .
End Current (mA)	
Start Data	Indicates the valid value range of signals of Feedback Parameter . Set the two parameters as required. An excessive range results in low precision of the feedback while an insufficient range results in the incompleteness of the feedback.
End Data	

- If the connected power meter is of another model, set the parameters as follows.

Parameter	Description
Intelligent Power Meter Type	Set this parameter to Other .
Read function code	Read holding register 03H and Read input register 04H are supported. Set this parameter based on the vendor's protocol.
Read mode	Multiple read and Single read are supported.
Word ordering	Big endian and Little endian are supported. Set this parameter based on the vendor's protocol.
Meter feedback output	Set this parameter based on whether the power meter needs to report the data of the grid-tied point.
Voltage change ratio	<ul style="list-style-type: none"> Set this parameter to 1 when the power meter uploads the primary value. Set this parameter based on the actual transformer ratio when the power meter uploads the secondary value.
Current change ratio	
Signal NOTE Signal-related parameters include Signal Name, Signal address, Number of Registers, Gain, Data Type, and Unit.	Set this parameter based on the vendor's protocol. NOTE If the power meter can collect a certain signal, set Signal address to the address of the corresponding register. If not, set Signal address to 65535 .
Feedback Parameter	Set this parameter based on the parameter name to be reported.
Start Current (mA)	Indicates the valid value range of signals carried by the analog output loop. The current range is less than or equal to the current range specified in the AO specifications. Start Data corresponds to End Data .
End Current (mA)	
Start Data	Indicates the valid value range of signals of Feedback Parameter . Set the two parameters as required. An excessive range results in low precision of the feedback while an insufficient range results in the incompleteness of the feedback.
End Data	

7.11.2.4 Setting Management System Parameters

To set parameters correctly, ensure that the SmartLogger can connect to Huawei management systems, such as NetEco and FusionSolar, or a third-party management system.

Because of permission restriction, log in as **Advanced User**. Choose **Settings > Management System** to access the page.

Figure 7-56 Setting management system parameters

Management System	
Server	<input type="text"/>
Port number	16100 (1~65535)
Address mode	Logical address
SSL encryption	Enable
Second challenge authentication	Disable
<input type="button" value="Submit"/> <input type="button" value="Network Test"/>	
Security Certificate	

NOTE

- Set **Server** to the IP address or domain name of the management system server.
- If the SmartLogger connects to the Huawei management system, retain the default value 16100 for **Port number**. If it connects to a third-party management system, set **Port number** based on the server port enabled in the third-party management system.
- In most cases, set **Address mode** to **Comm. Address**. If the devices connected to the six RS485 ports of the SmartLogger have duplicate communications addresses, you must set **Address mode** to **Logical address**.
- If **SSL encryption** is set to **Disable**, data will be transmitted without being encrypted, which may result in user data theft. Therefore, exercise caution when deciding to set **SSL encryption** to **Disable**.
- If **Second challenge authentication** is set to **Disable**, the second challenge authentication result will not be verified, which may result in user data theft. Therefore, exercise caution when deciding to set **Second challenge authentication** to **Disable**.
- Obtain the documents about security certificate from the management system.

7.11.2.5 Setting Modbus TCP Parameters

Set Modbus TCP parameters for the SmartLogger to communicate with a third-party NMS.

Because of permission restriction, log in as **Advanced User** or **Special User**. Choose **Settings > Modbus TCP** to access the target page.

Figure 7-57 Setting Modbus TCP parameters

Modbus TCP	
Link setting	Enable(Limited)
Client 1 IP Address	0. 0. 0. 0
Client 2 IP Address	0. 0. 0. 0
Client 3 IP address	0. 0. 0. 0
Client 4 IP address	0. 0. 0. 0
Client 5 IP address	0. 0. 0. 0
Address mode	Comm. Address
SmartLogger address	0 [0, 247]
<input type="button" value="Submit"/>	

 **NOTE**

- Modbus TCP is a universal standard protocol used to connect to a third-party management system. Because there is no security authentication mechanism, data transmitted by Modbus TCP is not encrypted. To reduce network security risks, the function of connecting to a third-party management system using Modbus TCP is disabled by default. This protocol can transmit the running data and control commands of PV plants, which may cause user data breach and control permission theft. Therefore, exercise caution when using this protocol. Users are liable for any loss caused by the use of this protocol to connect to a third-party management system (non-secure protocol). Users are advised to take measures at the PV plant level to reduce security risks, or use Huawei management system to mitigate the risks.
- To use this function, set **Link setting** to **Enable(Limited)** or **Enable(Unlimited)**. If you select **Enable(Limited)**, the SmartLogger can communicate with up to five third-party NMSs whose IP addresses are set under **Modbus TCP**. If you select **Enable(Unlimited)**, the SmartLogger can communicate with all third-party NMSs with valid IP addresses.
- In most cases, set **Address mode** to **Comm. Address**. If the devices connected to the COM ports of the SmartLogger have duplicate communications addresses, you must set **Address mode** to **Logical address**.

7.11.2.6 Setting IEC103 Parameters

Third-party devices that use the IEC103 interface protocol may be connected to PV plants. The SmartLogger can read the information about such third-party devices and upload the information to the NMS, enhancing the PV plant solution.

As Huawei inverter devices (such as SUN2000s) support protocols different from third-party devices that use standard IEC103 (such as box-type transformers, combiner boxes, and inverters), they cannot be connected in series on the same RS485 bus.

Mode for the SmartLogger to connect to the IEC103 device: When the SmartLogger connects to the NMS, it transparently transmits IEC103 device information to the NMS.

Because of permission restriction, log in as **Advanced User**. Choose **Settings** > **IEC103** to access the target page.

Figure 7-58 Setting IEC103 parameters

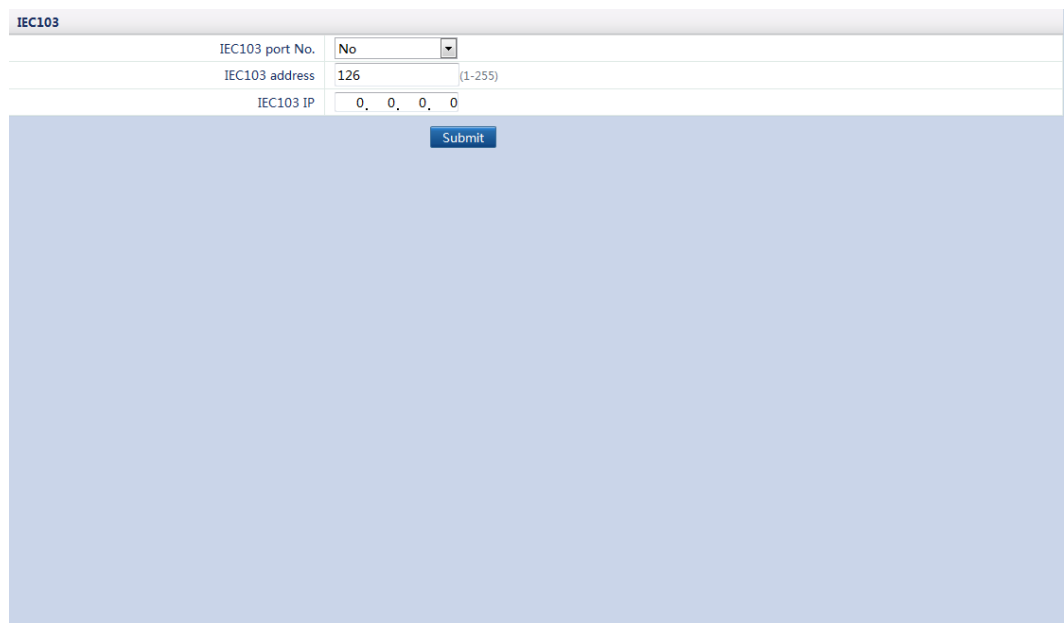

IEC103	
IEC103 port No.	No
IEC103 address	126 (1-255)
IEC103 IP	0. 0. 0. 0

[Submit](#)

NOTE

- Third-party devices and Huawei devices must be connected to different ports of the SmartLogger. Otherwise, the communication will be abnormal.
- The value of **IEC103 IP** must be consistent with the IP address of the NMS.

7.11.2.7 Setting IEC104 Parameters

- IEC104 is a universal standard protocol used to connect to a third-party management system. Because there is no security authentication mechanism, data transmitted by IEC104 is not encrypted. To reduce network security risks, the function of connecting to a third-party management system using IEC104 is disabled by default. This protocol can transmit the running data and control commands of PV plants, which may cause user data breach and control permission theft. Therefore, exercise caution when using this protocol. Users are liable for any loss caused by the use of this protocol to connect to a third-party management system (non-secure protocol). Users are advised to take measures at the PV plant level to reduce security risks, or use Huawei management system to mitigate the risks.
- The SmartLogger can connect to a maximum of five third-party NMSs.
- If the SmartLogger connects to a third-party NMS over the IEC104 protocol, IEC104 parameters must be correctly set to enable the third-party NMS to monitor the running status of devices connected to the SmartLogger.

Because of permission restriction, log in as **Advanced User**. Choose **Settings > IEC104** to access the target page.

Figure 7-59 Setting IEC104 parameters

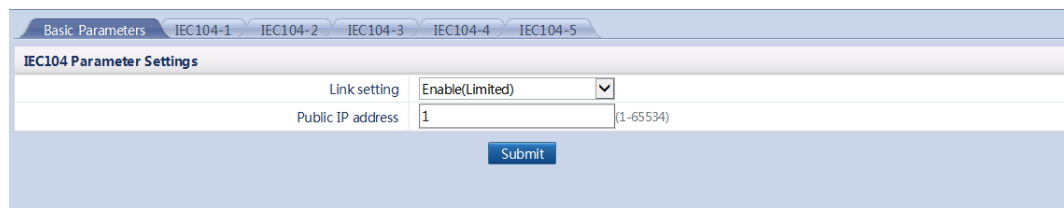
**NOTE**

- When IEC104 data point tables that require forwarding are different, set **Link setting** to **Enable(Limited)**. Set the data point tables to be forwarded in **IEC104-1–IEC104-5** tabs.
- When IEC104 data point tables that require forwarding are the same, set **Link setting** to **Enable(Unlimited)**. Set the data point tables to be forwarded in **Basic Parameters** tab.
- You can export an IEC104 configuration file in CSV format.

After the IEC104 configuration file exported from the SmartLogger and the device type IEC104 information files delivered with devices are correctly configured on a third-party NMS, the third-party NMS will be able to monitor the devices connected to the SmartLogger over the IEC104 protocol.

7.11.3 Extended Parameters

7.11.3.1 Setting FTP Parameters

- FTP is a universal standard protocol without any security authentication mechanism. Data transmitted by FTP is not encrypted. To reduce network security risks, the IP address of the connected third-party FTP server is left blank by default. This protocol can

transmit the running data of PV plants, which may cause user data breach. Therefore, exercise caution when using this protocol. Users are liable for any loss caused by the enabling of the FTP protocol (non-secure protocol). Users are advised to take measures at the PV plant level to reduce security risks, or use Huawei management system to mitigate the risks.

- The FTP function is used to access a third-party NMS. The SmartLogger can report the configuration information and running data of the managed plant system through the FTP. A third-party NMS can access Huawei devices with proper configurations.

Because of permission restriction, log in as **Advanced User**. Choose **Settings > FTP** to access the target page.

Figure 7-60 Setting FTP parameters

Basic parameters	
FTP server	<input type="text"/>
User name	<input type="text"/>
Password	<input type="text"/>
Remote directory	<input type="text"/>
Report Settings	
Data export	Disable <input type="button" value="v"/>
File format	Format 1 <input type="button" value="v"/>
File name	minYYMMDD.csv <input type="button" value="v"/>
Time format	YY-MM-DD <input type="button" value="v"/>
Export mode	Cyclic <input type="button" value="v"/>
Export interval	30 <input type="text"/> min (5~1440)
File mode	Accumulated data <input type="button" value="v"/>
Latest Report Status	
Status	Success
Last transmission	2000-01-01 00:00:00
<input type="button" value="Submit"/> <input type="button" value="Start report test"/>	

 **NOTE**

- **FTP server** can be set to the domain name or IP address of the FTP server. If **FTP server** is set to the domain name of the FTP server, ensure that the address of the DNS server on the [Ethernet](#) page is set correctly.
- **User name** and **Password** indicate the user name and password that need to be entered when you log in to the FTP server.
- After setting **Remote directory**, you can create a subdirectory in the default data upload directory (specified by the FTP server).
- If **Data export** is set to **Enable**, you can set the SmartLogger to report data regularly or at a specified time. If you set the SmartLogger to report data regularly, you can choose whether to report all data or only the incremental data of a day each time.
- In **FTP file format**, **Format 2** has two more information points than **Format 1**: E-Day (current-day energy yield) and E-Total (total energy yield). **Format 3** has more information points than the other two format files: multimeter, PID module, user-defined device, and SmartLogger data.
- The displayed formats of the file name and time can be set in **File Name** and **Time format**. **Y**, **M**, **D**, **H**, and **m** represent the year, month, day, hour (24-hour system), and minute respectively.

Table 7-14 Troubleshooting

Error Code	Troubleshooting Suggestion	Error Code	Troubleshooting Suggestion
0x1002	No FTP server address is	0x1003	1. Check whether the DNS

Error Code	Troubleshooting Suggestion	Error Code	Troubleshooting Suggestion
	configured. Configure the address correctly.		server address is correct. 2. Check whether the domain name of the third-party FTP server is correct.
0x1004	No FTP user name is configured. Configure the user name correctly.	0x1005	No FTP user password. Configure the user password correctly.
0x3001	1. Check whether the FTP server address is correct. 2. Check whether the third-party FTP server is working properly.	0x3002	1. Check whether the user name of the FTP server account is correct. 2. Check whether the user password is correct.
0x3007	Check whether data is allowed to be uploaded through a client to the third-party FTP server.	0x3008	Check whether there is a SmartLogger data upload directory on the third-party FTP server.

 **NOTE**

If the error code is not listed in this table, provide SmartLogger run logs and contact Huawei technical support.

7.11.3.2 Setting Email Parameters

The SmartLogger can send emails to inform users of the energy yield, alarm, and equipment status information of the PV plant system, helping users to know the running conditions of the PV plant system in time.

When using this function, ensure that the SmartLogger can be connected to the configured email server and that the Ethernet parameters and email parameters for the SmartLogger are correctly set. Ensure that no password is set between the SmartLogger and the email server.

Because of permission restriction, log in as **Advanced User**. Choose **Settings > Email** to access the target page.

Figure 7-61 Setting email parameters

NOTE

- **SMTP Server** can be set to the domain name or IP address of the SMTP server.
If it is set to the domain name of the SMTP server, ensure that the address of the DNS server is set correctly.
- **Encryption mode:** Set the encryption mode supported by mailboxes. Encryption is supported by most of the mainstream mailboxes such as Outlook, @qq.com, @126.com, @163.com, and @sina.com.
- **SMTP Port** specifies the port used for sending emails.
- **User name** and **Password** specify the user name and password used for logging in to the SMTP server.
- **Send address** specifies the sender's email address. Ensure that the sender's email server is the same as the server specified by **SMTP server**.
- You can click **Send test mail** to check whether the SmartLogger can successfully send emails to users.

Table 7-15 Troubleshooting

Error Code	Troubleshooting Suggestion	Error Code	Troubleshooting Suggestion
0x2002	<ol style="list-style-type: none"> 1. Check whether the DNS server address is correct. 2. Check whether the domain name or IP address of the SMTP server are correct. 3. Check whether the network communication between the SmartLogger and DNS is normal. 	0x2003	<ol style="list-style-type: none"> 1. Try again later. 2. Check whether the domain name or IP address of the SMTP server are correct.
0x200b	<ol style="list-style-type: none"> 1. Check whether the DNS server address is correct. 	0x4016	<ol style="list-style-type: none"> 1. Try again later. 2. Check whether the DNS server

Error Code	Troubleshooting Suggestion	Error Code	Troubleshooting Suggestion
	<ol style="list-style-type: none"> Check whether the domain name or IP address of the SMTP server are correct. Check whether the network communication between the SmartLogger and DNS is normal. 		<ol style="list-style-type: none"> address is correct. Check whether the domain name or IP address of the SMTP server are correct.
0x406e	Confirm the encryption mode and port supported by the mailbox, and check whether they are correctly configured.	0x8217	<ol style="list-style-type: none"> Check whether the user name and password are correct. Log in to the mailbox of the email sender and start the SMTP service. Log in to the mailbox of the email sender and start the third-party client license code function.
0xa003	Check whether the domain name or IP address of the SMTP server are correct.	0xa005	Check whether the user name is correct.
0xa006	Check whether the user password is correct.	0xe002	No domain name or IP address is configured for the SMTP server. Configure the domain name and IP correctly.
0xe003	Configure the addresses for sending and receiving emails correctly.	Other error codes	Provide SmartLogger run logs and contact Huawei technical support.

NOTE

If the error code is not listed in this table, provide SmartLogger run logs and contact Huawei technical support.

7.11.4 Port Settings

7.11.4.1 Setting DO Parameters

Context

The SmartLogger provides three DO ports. Connect one DC power cable of the 3G router to one of the DO ports, and power on and off the wireless module by disconnecting and connecting the DO dry contact to control the reset of the 3G router.

Considering the restrictions on the current that can pass through the DO port of the SmartLogger, you need to determine the number of DO ports to be used for the control based on the maximum power supply current of the 3G router (the maximum power supply current can be calculated based on the maximum power consumption and DC power supply voltage). When the power supply current is less than 0.5 A and the voltage is lower than 12 V, use one DO port.

Connecting a 3G Router over a DO Port

When connecting a 3G router, cut off one DC power cable of the router, and connect the cable to a DO port of the SmartLogger.

Figure 7-62 Connecting one DO port

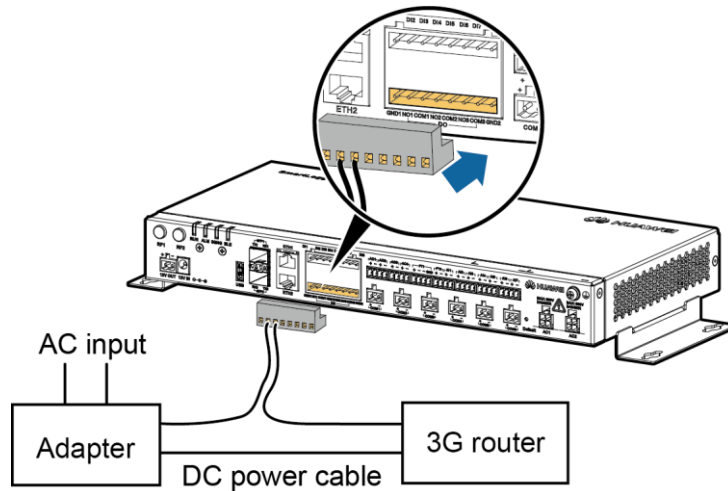

IL02110020

DO Configuration

After connecting the 3G router to the SmartLogger properly, you can set DO parameters over the WebUI to enable the external 3G router to automatically reset if the SmartLogger fails to connect to the NetEco, email server, or FTP server within 30 minutes.

Because of permission restriction, log in as **Advanced User**. Choose **Settings > DO** to access the target page.

Figure 7-63 DO configuration

DO Configuration	
DO1	No control
DO2	No control
DO3	No control

7.11.4.2 Setting USB Parameters

Context

The SmartLogger has a USB port, which provides 5 V/1 A power supply. If the DC power cable of the 3G router has a standard USB connector with a maximum current of less than 1 A, it can directly connect to the USB port on the SmartLogger, power the 3G router over the SmartLogger, and disconnect the USB port power supply when the communication fails.

NOTICE

If the maximum working current of the 3G router is greater than 1 A, it cannot be connected over a USB port.

Connecting a 3G Router over a USB Port

Connect the USB connector of the DC power cable for the 3G router to the USB port of the SmartLogger.

Figure 7-64 Connecting the 3G router and the SmartLogger

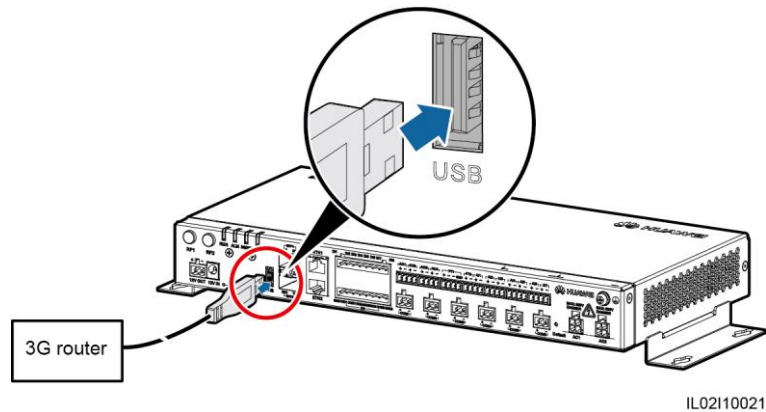

USB Configuration

After connecting the 3G router to the SmartLogger properly, you can set USB parameters over the WebUI to enable the external 3G router to automatically reset if the SmartLogger fails to connect to the NetEco, email server, or FTP server within 30 minutes.

Because of permission restriction, log in as **Advanced User**. Choose **Settings > USB** to access the target page.

Figure 7-65 USB configuration

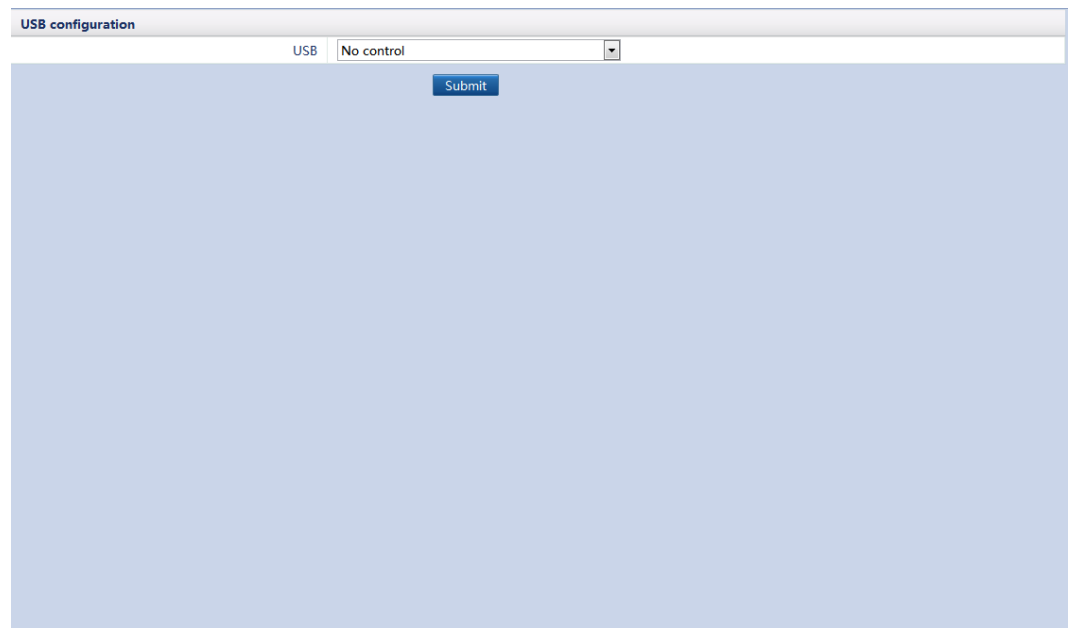

7.11.5 Alarm Output

After an inverter alarm is linked to a DO port, the alarm signal is delivered from the DO port when the inverter generates the alarm.

Because of permission restriction, log in as **Advanced User**. Choose **Settings > Alarm Output**.

NOTE

- Before linking an inverter alarm to a DO port, ensure that the DO port is not set for other purposes. Otherwise, the setting will fail.
- After the function is enabled, the DO port status may change and the alarm output may be abnormal if the SmartLogger restarts or powers off.

Figure 7-66 Alarm output

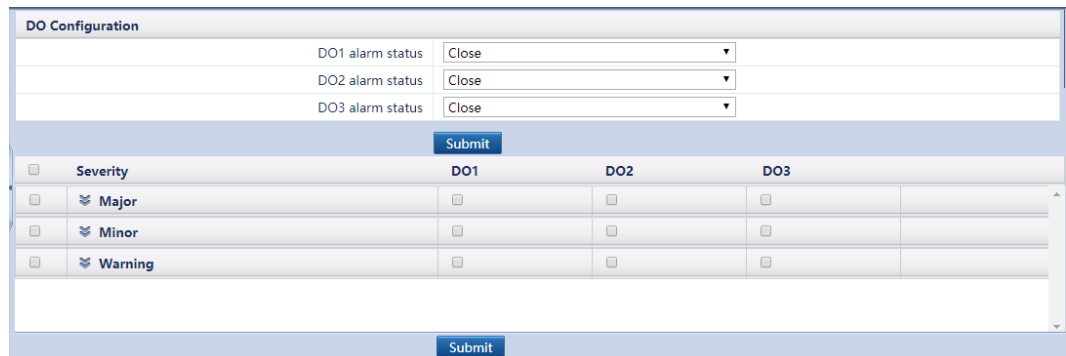

7.11.6 Setting Smart Tracking Algorithm Parameters

Context

- After the parameters related to the smart tracking algorithm are set based on the tracker status and weather conditions, the trackers can automatically adjust their angle so that the PV plant system can obtain the maximum energy yield and prevent damage to PV modules caused by bad weather, thereby improving benefits.
- You need to purchase a valid license for the smart tracking algorithm and load the license before enabling it.

Procedure

Step 1 Log in as **Advanced User**, set smart tracking algorithm parameters, and click **Submit**.

Figure 7-67 Smart tracking algorithm

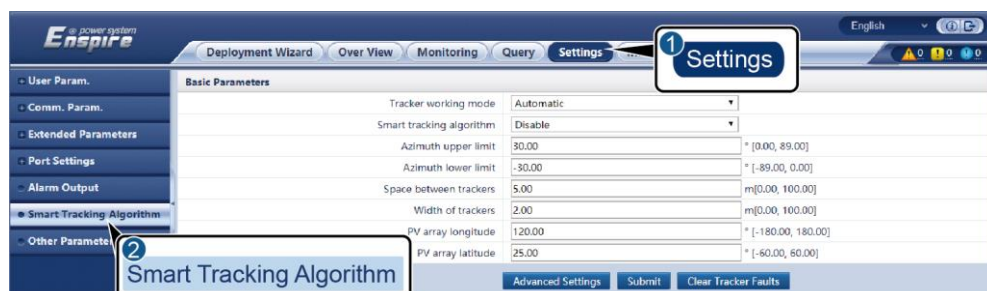

IL02J00012

Parameter	Description
Tracker working mode	<p>Sets the working mode of the trackers.</p> <ul style="list-style-type: none"> • Maintenance mode: The function is reserved. • Automatic: The trackers can automatically adjust the angle based on the illumination to optimize the energy yield. • Manual: Set the working mode of the trackers in the PV array to Manual in batches. • Strong wind: When a strong wind occurs, you are advised to set this mode to protect the tracker system. • Heavy snow: When heavy snow occurs, you are advised to set this mode to protect the tracker system. • Heavy rain: When heavy rain occurs, you are advised to set this mode to protect the tracker system. • Cloudy day: When the weather is cloudy, you are advised to set this mode to protect the tracker system. • Stop tracking: The function is reserved. • Custom: The function is reserved.
Smart tracking algorithm	<p>When this parameter is set to Enable and Tracker working mode is set to Automatic, you can set the tracker parameters to enable the trackers to automatically adjust their angle based on the illumination to optimize the energy yield.</p> <p>NOTE When you need to set the parameters related to trackers, set Smart tracking algorithm to Disable. After the tracker parameters are set, set Smart tracking algorithm to Enable.</p>
Azimuth control upper limit	Set this parameter based on the technical specifications of the tracker.
Azimuth upper limit	
Space between trackers	Set this parameter based on the space between trackers in the PV array.
Width of trackers	Set this parameter based on the width of trackers in the PV array.
PV array longitude	Set these parameters based on the longitude and latitude of the PV array.
PV array latitude	

Table 7-16 Advanced configuration (You are advised to retain the default value.)

Parameter	Description
Delivered angle threshold	An angle is delivered to the inverter or tracker only when it exceeds the threshold.
Data record (USB flash	When this parameter is set to Enable , the angle data and

Parameter	Description
drive)	power data of the tracker can be saved to a USB flash drive.
Data record period	Indicates the interval for storing the tracker records to a USB flash drive.
Tracker control on cloudy and rainy days	Indicates whether to enable the function of controlling trackers on cloudy and rainy days.
Start delay	According to Solar elevation angle threshold and Start load rate threshold , if the duration of the cloudy and rainy weather is within Start delay , Tracker control on cloudy and rainy days is enabled.
Exit delay	According to Solar elevation angle threshold and Start load rate threshold , if the cloudy and rainy weather disappears for a period of time that is within Exit delay , Tracker control on cloudy and rainy days is disabled.
Angle coefficient	On cloudy and rainy days, the (target) angle of trackers equals to the reference angle multiplied by the angle coefficient.
Solar elevation angle threshold	When the solar elevation angle is greater than this value, the function of controlling trackers on cloudy and rainy days starts to work.
Start load rate threshold	The load rate is the ratio of the actual PV array power to the rated power. When the load rate of the PV array is less than the threshold, the function of controlling trackers on cloudy and rainy days is enabled.
Exit load rate threshold	When the load rate of the PV array is greater than the threshold, the function of controlling trackers on cloudy and rainy days is disabled.
Load rate statistics window	The average load rate is calculated based on the historical value of the load rate. This parameter determines the number of historical values that are used to calculate the average load rate.
Shadow identification	Indicates whether to enable the shadow identification function.
Shadow elimination target	Ensure that the PV strings that belong to the shadow elimination target are not shaded.
Power reference coefficient	Indicates the power threshold ratio of the PV strings that are shaded. For example: If the average power of the top 5% of PV strings is 1 kW and the threshold ratio is 70%, the actual power of the PV string is 700 W. The PV strings whose actual power is lower than 700 W are shaded.
Exporting performance data	Export the performance data of the tracker for data analysis and problem location.

Parameter	Description
Re-identify	Indicates whether to restart shadow optimization.

----End

7.12 Maintenance

7.12.1 Upgrading Firmware

You can upgrade the firmware of the SmartLogger, inverter, SmartMBUS, or PID module over the WebUI.

Because of permission restriction, log in as **Advanced User** or **Special User**. Choose **Maintenance > Firmware Upgrade** to access the target page.

1. Upload the upgrade file of the device to be upgraded. The upgrade file automatically matches the device name and selects all devices of this type.
2. (Optional) If you do not need to upgrade a device, clear the device.

NOTE

For the patch version earlier than the SUN2000 V100R001C11SPC409, SUN2000 V100R001C81SPC101, or SUN2000 V200R001C00, only one inverter can be upgraded. After the upgrade file is uploaded, select only one inverter for upgrade and clear other inverters.

3. Click **Upgrade**.

Figure 7-68 Upgrading firmware

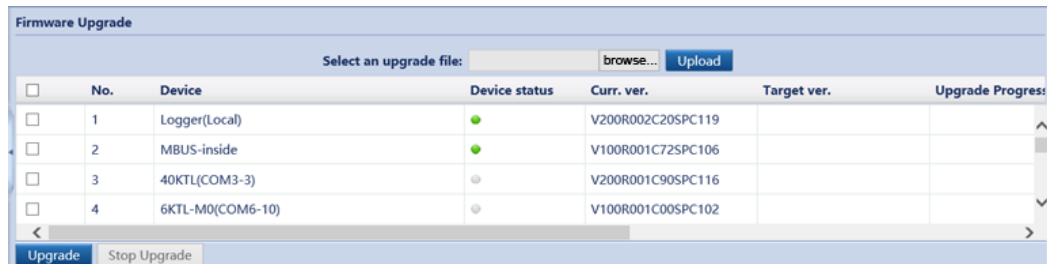

NOTE

The **Stop Upgrade** function is only effective for the devices waiting to be upgraded.

7.12.2 Product Information

Choose **Maintenance > Product Information** and query SmartLogger information on the displayed page.

Figure 7-69 Product information

Product Information	
SN	2102311RTD10GB000014
Device type	SmartLogger2000
Firmware Version	V200R002C20SPC119

7.12.3 Setting Security Parameters

Choose **Maintenance > Security Settings** to access the target page.

Figure 7-70 Setting security parameters

User Name	Special User	Device status	Online
Password Change			
Automatic logout time			
Automatic logout time	Never		
Submit			
Network Security Certificate			
Select a certificate format	CRT format		
Please select a security certificate	choose file security c...ificate.crt	Upload	
Select the network security certificate key to be uploaded	choose file network s...te key.crt	Upload	
	<input type="checkbox"/> Enable key password		
Submit			
Update Key			
Update			
WEB TLS1.0 Setting			
TLS1.0 enable	Enable (The WebUI will restart after the setting is modified. Enabling this item will pose security risks.)		
Submit			
Digital Signature Verification			
Digital signature verification for upgrade package	Disable		
Submit			

NOTE

- The initial password is *Changeme* for system users **Common User**, **Advanced User**, and **Special User**.
- Use the initial password upon first power-on and change it immediately after login. To ensure account security, change the password periodically and keep the new password in mind. Not changing the initial password may cause password disclosure. A password left unchanged for a long period of time may be stolen or cracked. If a password is lost, devices cannot be accessed. In these cases, the user is liable for any loss caused to the PV plant.
- You are advised to change the password at least once every half a year to prevent unauthorized use of your account and impact on system security.
- After **Automatic logout time** is set, a user is automatically logged out if the user does not perform any operation within the specified time period.
- You are advised to use the existing network security certificate and key.

Change the password in compliance with the following rules:

- Containing 6 to 20 characters

- A combination of at least two types of digits, uppercase letters, and lowercase letters
- Different from the old password

7.12.4 System Maintenance

Because of the permission restriction, log in as **Advanced User** or **Special User**. Choose **Maintenance > System Maint..**

Figure 7-71 System maintenance

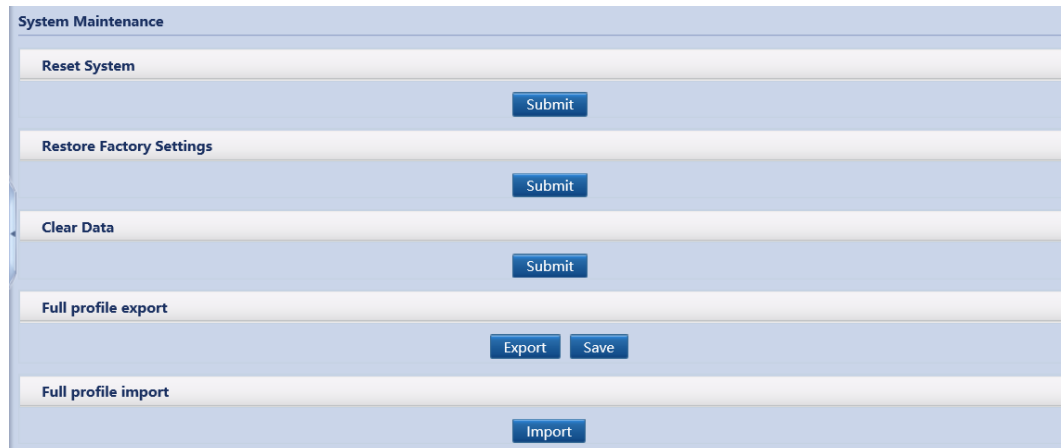

7.12.5 Device Log

Because of permission restriction, log in as **Advanced User** or **Special User**. Choose **Maintenance > Device Log** to access the target page.

Figure 7-72 Device log

Select	No.	Device	SN	Device status	Progress	Execution Statu
<input type="checkbox"/>	1	Logger(Local)	2102311RTD10GB000014	●		
<input type="checkbox"/>	2	MBUS-inside	PLC002311RTDGB000014	●		
<input type="checkbox"/>	3	40KTL(COM3-3)	210107250110E6000015	●		
<input type="checkbox"/>	4	6KTL-M0(COM6-10)	21010743150123456789	●		
<input type="checkbox"/>	5	12KTL-M0(COM6-11)	21010743060123456780	●		
<input type="checkbox"/>	6	40KTL(COM6-12)	210107296610F8000016	●		
<input type="checkbox"/>	7	100KTL(COM6-13)	21010741816THC900004	●		
<input type="checkbox"/>	8	60KTL-M0(COM6-14)	6T1899025042	●		

Buttons: Export Log, Stop Export, Log archiving

7.12.6 Site Test

After a inverter is put into use, it should be inspected periodically to detect any potential risks and problems. The SmartLogger can inspect inverters over the WebUI.

Because of permission restriction, log in as **Advanced User** or **Special User**. Choose **Maintenance > Onsite Test** to access the target page.

Figure 7-73 Site test

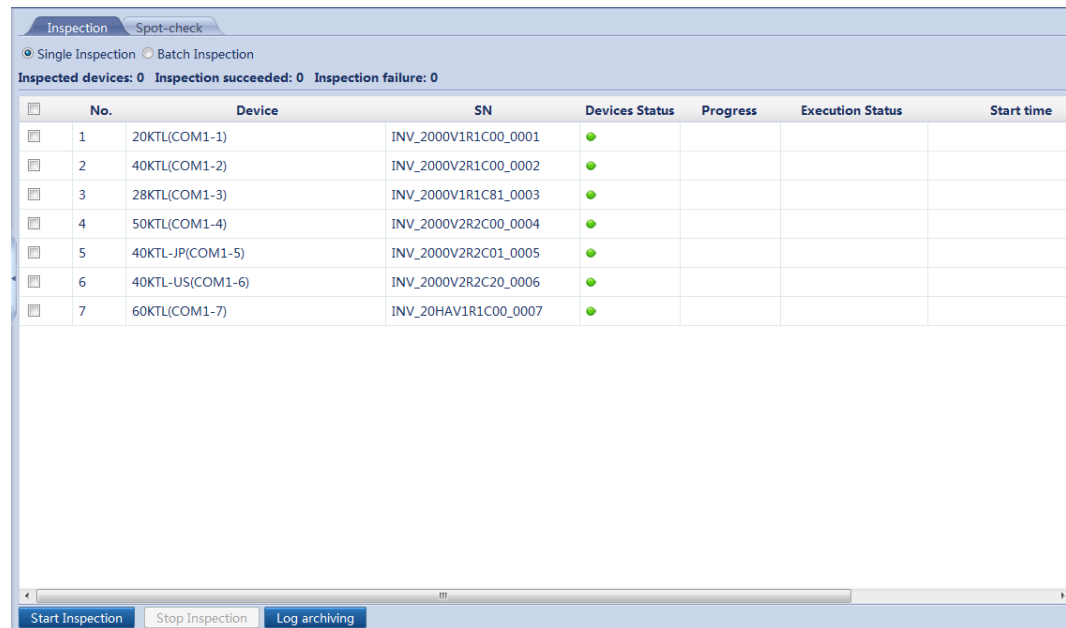

No.	Device	SN	Devices Status	Progress	Execution Status	Start time
1	20KTL(COM1-1)	INV_2000V1R1C00_0001	●			
2	40KTL(COM1-2)	INV_2000V2R1C00_0002	●			
3	28KTL(COM1-3)	INV_2000V1R1C81_0003	●			
4	50KTL(COM1-4)	INV_2000V2R2C00_0004	●			
5	40KTL-JP(COM1-5)	INV_2000V2R2C01_0005	●			
6	40KTL-US(COM1-6)	INV_2000V2R2C20_0006	●			
7	60KTL(COM1-7)	INV_20HAV1R1C00_0007	●			

NOTE

- The spot-check function is available only for the inverter for which **Grid Code** is set to **Japan standard**.
- You can click the Select icon in the upper left corner of the page to select an inspection mode.

7.12.7 Managing the License

Context

The smart I-V diagnosis, smart PV string monitoring, smart tracking algorithm, and smart reactive power compensation can be used only after a license is purchased. The license file for smart I-V diagnosis and string monitoring is stored in the inverter, and the license file for smart tracking algorithm and smart reactive power compensation is stored in the SmartLogger. The matching between the SN of a device and a license is unique.

You can view and obtain the license information on the **License Management** page. Before a device is replaced, the current device license needs to be revoked so that the revocation code can be generated and used for applying for a new device license.

Procedure

- Step 1** Log in as **Advanced User** or **Special User** to go to the **License Management** page.

Figure 7-74 License management

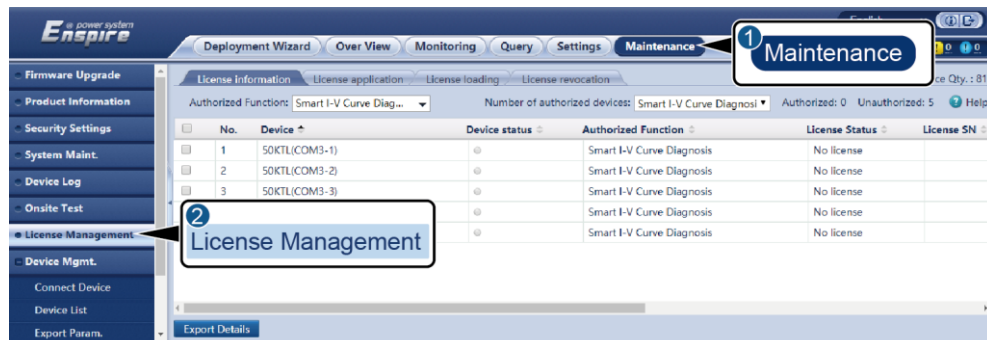

IL02J00015

Tab page	Function	Operation Instructions
License information	Views related information about the device.	<ol style="list-style-type: none"> 1. Select the name of the device whose license details are to be exported. 2. Click Export Details.
License application	Exports the license application file of the device.	<ol style="list-style-type: none"> 1. Select the name of the device whose license file is to be exported. 2. Click Export License Appli File.
License loading	Loads the obtained license file to the device.	<ol style="list-style-type: none"> 1. Click Upload License. 2. Select the name of the device whose license file is to be loaded. 3. Click Load License.
License revocation	Revokes a license that has taken effect or exports the revocation code file.	<ol style="list-style-type: none"> 1. Select the name of the device whose license file is to be revoked. 2. Click Revoke License. 3. Click Export Revo Code File.

NOTE

Ensure that the extension of the license file to be imported is .dat or .zip.

----End

7.12.8 Device Management

7.12.8.1 Connecting Devices

Because of permission restriction, log in as **Advanced User** or **Special User**. Choose **Maintenance > Connect Device** to access the target page.

Figure 7-75 Connecting devices

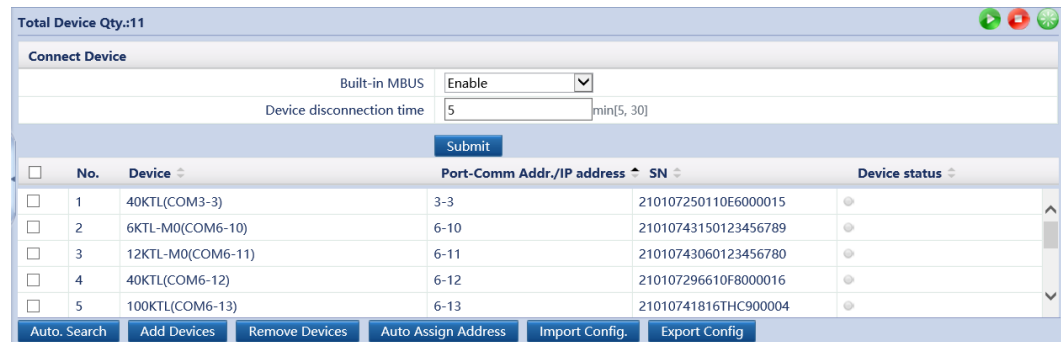

NOTE

- When the built-in MBUS is adopted for communication between the SmartLogger and SUN2000, set **Built-in MBUS** to **Enable**. When RS485 communication is adopted for communication between the SmartLogger and SUN2000 or third-party devices, set **Built-in MBUS** to **Disable**.
- Huawei devices including the SUN2000, SmartMBUS, and PID module can be connected to the SmartLogger through automatic search or manual configuration. The EMI, electricity meter, smart transformer station (STS for short), and third-party devices can be connected to the SmartLogger only through manual configuration.
- If the devices connecting to different RS485 ports on the SmartLogger have address conflict (such as COM1-1 and COM2-1), and the SmartLogger is communicating with a Huawei or third-party NMS, set **Address mode** to **Logical address**. For details, see [7.11.2.4 Setting Management System Parameters](#) and [7.11.2.5 Setting Modbus TCP Parameters](#). If you do not set the parameter, ensure that the device connecting to each RS485 port has a unique address.
- Before manually adding the EMI connected through the COM port, set the RS485 parameters correctly. For details, see [7.11.2.2 Setting RS485 Parameters](#). When adding the EMI, set **Device Type** to **EMI** and **Connection mode** to **Modbus-RTU**. When manually adding the EMI connected through the AI or PT port, there is no need to set RS485 parameters. When adding the EMI, set **Device Type** to **EMI** and **Connection mode** to **AI**. After adding an EMI manually, correctly set the EMI parameters. For details, see [7.9.4 EMI](#).
- Before manually adding the STS connected through the COM port, set the RS485 parameters correctly. For details, see [7.11.2.2 Setting RS485 Parameters](#). When adding the STS, set **Device Type** to **STS**, **Port number** to the COM port number connected to the SmartLogger from the STS, and **Address** to the communication address of the STS. After manually adding an STS, check whether the air circuit breaker in low-voltage cabinet A, air circuit breaker in low-voltage cabinet B, and circuit breaker in the transformer can be switched on and off properly. For details, see [7.9.9.2 Setting STS Parameters](#).
- Before manually adding the Modbus or DL/T645 electricity meter, set RS485 parameters correctly by following the instructions in [7.11.2.2 Setting RS485 Parameters](#). Before manually adding the Modbus electricity meter, correctly set the electricity meter parameters. For details, see [7.11.2.3 Setting Power Meter Parameters](#). When adding an electricity meter, set **Device Type** to **Power Meter** and **Comm.protocol** to the protocol supported by the electricity meter.
- Before manually adding a slave SmartLogger, set the Modbus TCP parameters correctly. Set **Link setting** to **Enable(Limited)** and enter the IP address of the master SmartLogger in **Client IP address**. For details, see [7.11.2.5 Setting Modbus TCP Parameters](#). When adding the slave SmartLogger, set **Device Type** to **SmartLogger** and enter the IP address of the slave SmartLogger in **IP address**.
- When connecting a third-party device, import a configuration file for the device, and then manually add the device.
- An accessed device can be removed manually, and a removed device can be added again.
- **Auto Assign Address** allows you to adjust device addresses based on serial numbers. If a device cannot access due to address conflict, perform this operation to assign a new device address and then access the device.

- After the device is connected, you can export the device configuration. When changing the name of the exported file, retain the extension **.cfg**. Otherwise, the file cannot be functional.
- You can click the Start, Stop, or Reset icon to send the corresponding command to all inverters connected to the SmartLogger.

7.12.8.2 Device List

Because of permission restriction, log in as **Advanced User** or **Special User**. Choose **Maintenance > Device list** to access the target page.

Figure 7-76 Device list

Total Device Qty.:12

<input type="checkbox"/>	No.	Device	port	Comm Address	Logical addr.	Transformer No.	Winding No.
<input type="checkbox"/>	1	MBUS-inside	MBUS	249	14	110	1
<input type="checkbox"/>	2	40KTL(COM3-3)	3	3	6	1	1
<input type="checkbox"/>	3	6KTL-M0(COM6-10)	6	10	19	--	--
<input type="checkbox"/>	4	12KTL-M0(COM6-11)	6	11	21	--	--
<input type="checkbox"/>	5	40KTL(COM6-12)	6	12	2	511	1
<input type="checkbox"/>	6	100KTL(COM6-13)	6	13	8	0	0

NOTE

You can modify the device name and address on the WebUI, or export a device information file in CSV format and import the CSV file into the WebUI after modification.

7.12.8.3 Exporting Parameters

Because of permission restriction, log in as **Advanced User** or **Special User**. Choose **Maintenance > Export Param.** to access the target page.

Figure 7-77 Exporting data

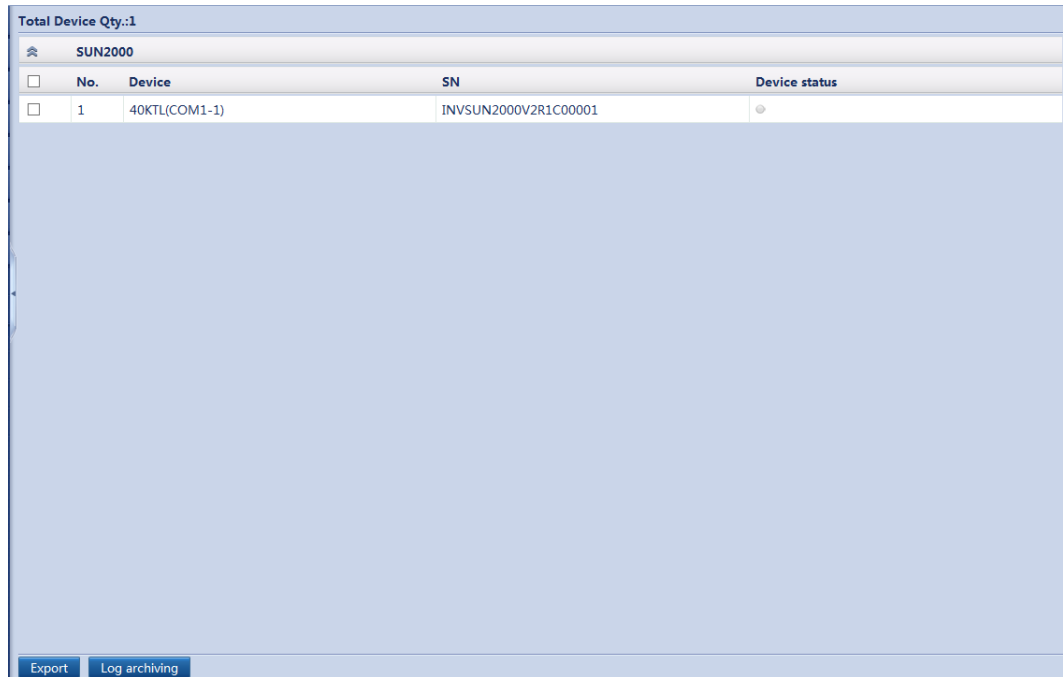

Total Device Qty.:1				
SUN2000				
<input type="checkbox"/>	No.	Device	SN	Device status
<input type="checkbox"/>	1	40KTL(COM1-1)	INVSUN2000V2R1C00001	●

Export Log archiving

NOTE

You can export configuration parameters of multiple inverters to a .csv file. Site engineers can then check whether the inverter configurations are correct in the exported file.

7.12.8.4 Clearing Alarms

If you need to clear the active and historical alarms of certain or all devices connecting to the SmartLogger, and re-collect alarm data, perform this operation.

Because of permission restriction, log in as **Advanced User** or **Special User**. Choose **Maintenance > Clear Alarm** to access the target page.

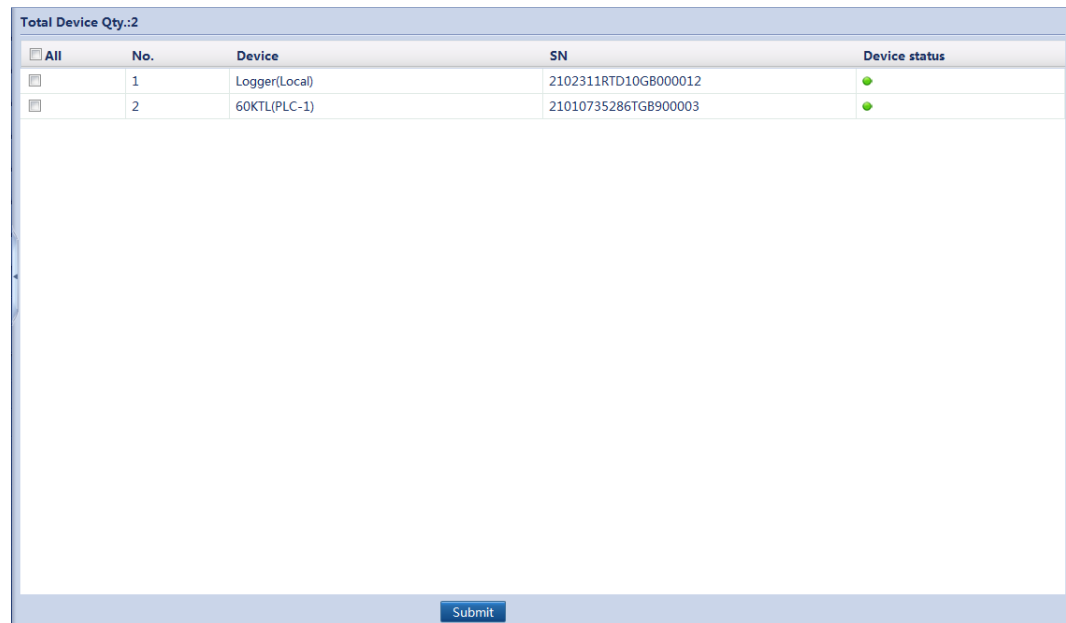
Figure 7-78 Clearing alarms

The screenshot shows a web interface titled "Total Device Qty.:2". It contains a table with the following columns: "All" (with a checkbox), "No.", "Device", "SN", and "Device status". There are two rows of data:

<input type="checkbox"/> All	No.	Device	SN	Device status
<input type="checkbox"/>	1	Logger(Local)	2102311RTD10GB000012	●
<input type="checkbox"/>	2	60KTL(PLC-1)	21010735286TG8900003	●

At the bottom of the interface, there is a blue "Submit" button.

NOTICE

- By clearing alarms, users can clear all active and historical alarms for the selected device and enable the SmartLogger to re-collect alarm data.
- By clearing alarms, users can clear the local SmartLogger alarms or device storage alarms. If the version of the SUN2000-(8KTL-28KTL) is earlier than SUN2000 V100R001C81, users can only clear local SmartLogger alarms by performing the operation.
- If **Clear Alarm** is performed for the Huawei devices such as the inverter and PID, **Alarm Reset** must be performed on the NMS. Otherwise the SmartLogger cannot collect alarm data from the devices after alarms are cleared.
- If **Clear Alarm** is performed for the SmartLogger, **Alarm Reset** must be performed on the NMS. Otherwise the SmartLogger cannot collect alarm data from the devices after **Alarm Reset** is performed.

7.12.8.5 Data Recollection

Users can recollect previous performance data and energy yield over the WebUI. The recollection results can be queried on the **Monitoring** page.

NOTE

- This function is not supported by the SUN2000-(8KTL-28KTL).
- When you perform data recollection and query the performance data of the inverter after the SUN2000-33KTL/40KTL software is upgraded from SUN2000 V200R001C00SPCXXX to SUN2000 V200R001C90SPCXXX, the current-day energy yield generated before the upgrade cannot be queried.

Because of permission restriction, log in as **Advanced User** or **Special User**. Choose **Maintenance > Data Re-collection** to access the page.

1. Select the data recollection type and the corresponding recollection period.
2. Select the inverter whose data needs to be recollected.

3. Click **Collect Data**.
4. Click different tabs to view the data recollection progress and status. Data is recollected in the sequence of performance data, daily energy yield, monthly energy yield, and annual energy yield.

Figure 7-79 Data recollection

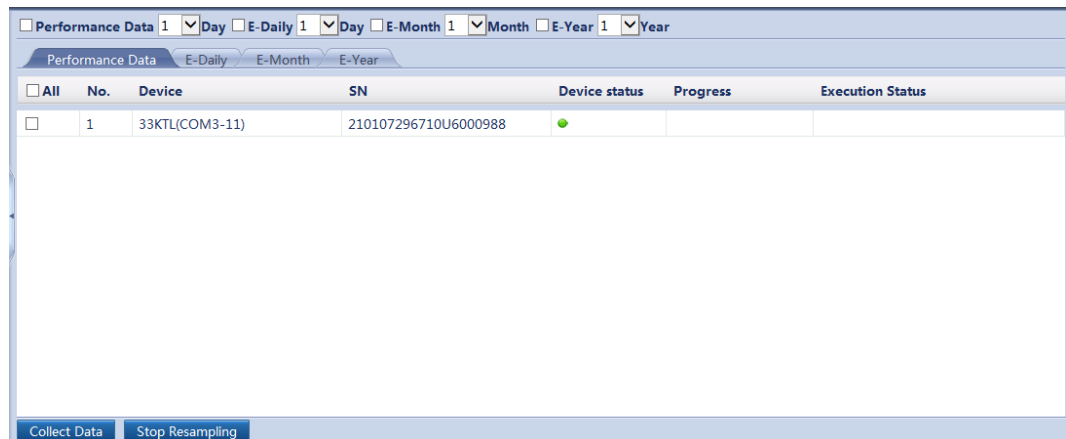

7.12.8.6 Correcting the Total Energy Yield

Because of permission restriction, log in as **Advanced User** or **Special User**. Choose **Maintenance > Adjust total energy yield** to access the target page.

Figure 7-80 Correcting the total energy yield

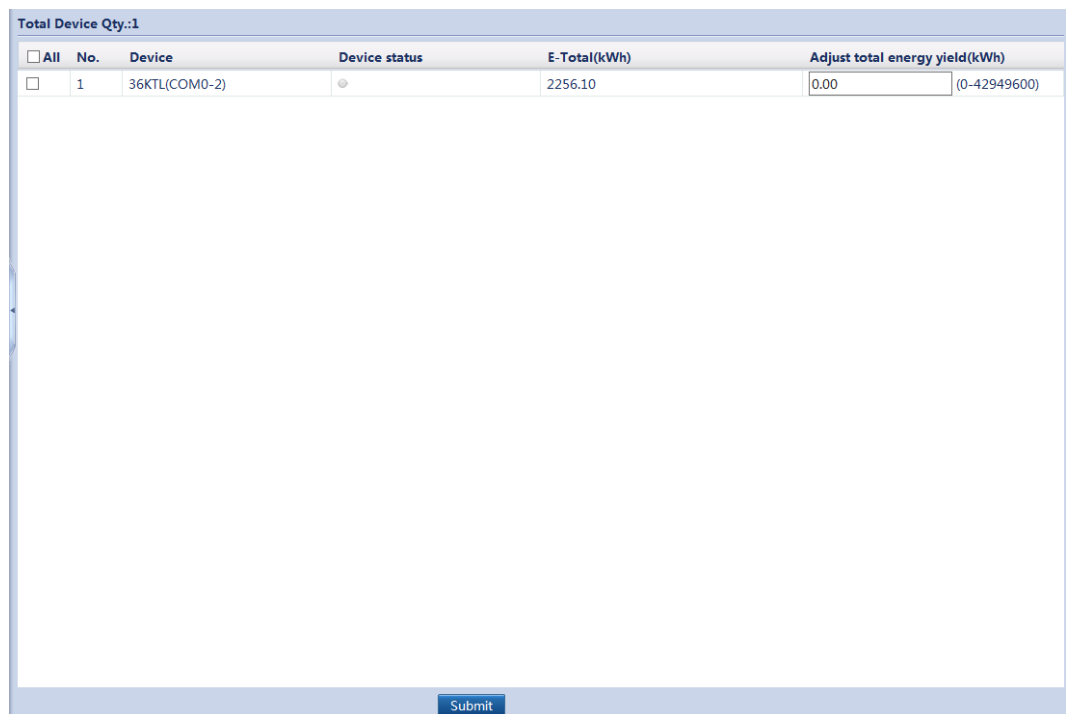

8 Power Grid Scheduling

According to standard requirements, the SmartLogger can reliably adjust power for the connected inverters in real time to ensure that the PV plant can respond to requirements of the power grid company in a timely manner.

8.1 Active Power Control

NOTE

- If the PV plant has requirements of power limitation, the power grid scheduling personnel should limit the active power or disable all the active power for the PV plant, that is, to enable the active power derating mode.
 - The active power control mode includes the following: No limit, DI active scheduling, Percentage fixed-value limitation (open loop), Remote communication scheduling, Grid connection with limited power (kW), and Remote output control.
1. Log in as **Special User**, go to the **Active power control** page, set active power control parameters, and click **Submit**.

Figure 8-1 Active Power Control

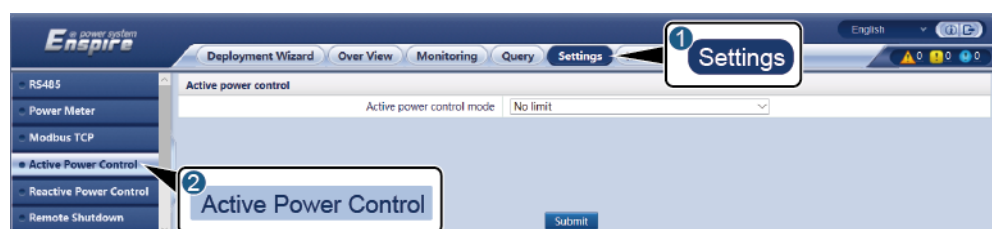

IL02J00019

8.1.1 No Limit

Parameter	Description
Active Power Control Mode	Set this parameter to No limit and the inverters will run at full load.

8.1.2 DI Active Scheduling

NOTICE

- When setting this function, ensure that the DI port for customized control is not occupied. Otherwise, the setting will fail.
- Before setting this function, ensure that the SmartLogger is properly connected to the Ripple Control Receiver.

Parameter	Description
Active Power Control Mode	Set this parameter to DI active scheduling .
DI NOTE The DI parameters include DI1, DI2, DI3, DI4, and Percentage(%) .	<ul style="list-style-type: none"> • Supports 16 levels of percentages. • "\-/" indicates a low level. When DI+ and DI- are connected, the four DI ports of the SmartLogger are low-level ports. If not connected, the ports are high-level ports. • The percentage levels of DI1–DI4 should differ from each other. Otherwise, an abnormal command will be generated. • If the actual input DI signal is inconsistent with that configured on the WebUI, the SmartLogger controls the inverter to work at full power and the Abnormal Reactive Schedule alarm is raised.

8.1.3 Percentage Fixed-value Limitation (Open Loop)

The SmartLogger provides simplified active power percentage configuration as well as power control automation, that is, to automatically adjust the active power derating percentage in different periods of the day.

Parameter	Description
Active Power Control Mode	Set this parameter to Percentage fixed-value limitation (open loop) to control the maximum output power of the inverter by time segment.
Start time	<p>If the inverters are required to run with specified maximum power in certain periods of a day, add setting records based on site requirements.</p> <p>When multiple time points are set, the inverters will run with the maximum power specified for the time point that is earlier than and the closest to the system current time point. For example, if you add 00:00:00 and 12:00:00 on the WebUI and the system current time point is 14:30:00, the inverters will run with the maximum power specified for 12:00:00.</p>
Percentage(%)	

8.1.4 Remote Communication Scheduling

The NMS or independent power adjustment device sends scheduling commands over the communications port that works with Modbus-TCP or IEC104, without the need of user configuration or operation. The SmartLogger can automatically switch between scheduling modes and send scheduling commands.

Parameter	Description
Active power control mode	<p>Set this parameter to Remote communication scheduling.</p> <p>The SmartLogger receives the scheduling commands from the upper NMS, resolves the commands for the inverters, and then sends the commands to all connected inverters.</p> <p>Based on the Remote communication scheduling priority principle, the SmartLogger automatically changes Active power control mode to Remote communication scheduling after receiving a scheduling command from the upper NMS.</p>
Schedule strategy	<p>Supports Disable, Strategy 1, and Strategy 2.</p> <ul style="list-style-type: none">• Disable: The SmartLogger controls the inverter to work at full load and will not receive scheduling commands from the NMS.• Strategy 1: Open-loop scheduling policy. That is, the SmartLogger evenly allocates the power value from the scheduling device and delivers the average values to each inverter, which then operates with the specific power. The adjustment value delivered by the SmartLogger is constant. After you set Adjustment coefficient, the power value is multiplied by the configured coefficient and then delivered to the inverter.• Strategy 2: This function is customized for a single site. Set Overshoot, Adjustment period, and Adjustment deadband based on the site scheduling requirements.

8.1.5 Grid Connection with Limited Power (kW)

NOTICE

- You are advised to choose **Settings > Grid connection with limited power** and enable the grid connection with limited power function.
- To enable this function, you need to set power meter, inverter, and grid connection with limited power parameters. This section describes how to set grid connection with limited power parameters.
- Before setting the parameters, ensure that a power meter has been connected to the SmartLogger.

Step 1 Set grid connection with limited power (kW) parameters and click **Submit**.

Parameter	Description
Active power control mode	Set this parameter to Grid connection with limited power (kW) .
Power meter	Set this parameter to Smart meter . Otherwise, the function will not take effect.
Electric meter power direction	When the inverter has no output power, set this parameter to Positive if the active power reading of the power meter is positive. Otherwise, set this parameter to Reverse .
Limitation mode	<ul style="list-style-type: none"> • Total power: controls the total power at the grid-tied point to limit the power fed to the power grid. • Single-phase power: controls the power of each phase at the grid-tied point to limit the power fed to the power grid.
Maximum grid feed-in power	Indicates the maximum power that the inverter can feed into the power grid. Suggestion: Set this parameter based on the export limitation threshold allowed by the power grid company.
Power lowering adjustment period	Specifies the period for lowering the inverter output power.
Maximum protection time	Specifies the maximum duration from the time when the SmartLogger detects backflow to the time when the inverter output power reaches 0. Suggestion: Set this parameter based on the maximum backflow duration allowed by the power grid company.
Power raising threshold	Specifies the threshold for raising the inverter output power.
Fail-safe power threshold	Inverter output power percentage is controlled by the SmartLogger when communication between the SmartLogger and the power meter is abnormal.
Switch-off with 0% power limit	Specifies whether the DO port is allowed to control switch-off.
Switch-off control port	Set this parameter to the DO port that controls switch-off.
Switch-on control port	Set this parameter to the DO port that controls switch-on.
Switch-off state feedback port	Set this parameter to the DI port that reports the switch-off status.
Switch-on state feedback port	Set this parameter to the DI port that reports the switch-on status.

Step 2 Verify that the SmartLogger can remotely turn on and off circuit breakers in scenarios with circuit breakers.

- Click **Switch off** to check whether a circuit breaker can be switched off properly.
- Click **Switch on** to check whether a circuit breaker can be switched on properly.

----End

8.1.6 Remote Output Control

Step 1 Log in as **Advanced User** and synchronize the clock source of the server.

Path	Parameter Name	Description
Settings > User Param. > Date	Clock source	Set this parameter to NTP .
	Server	Set this parameter to the IP address or domain name of the NTP server.
	NTP synchronization test	Checks the time synchronization status.

Step 2 Log in as **Special User** and set the remote output control parameters.

Path	Parameter Name	Description
Settings > Active power control	Active power control	Set this parameter to Enable .
	Active power control mode	Set this parameter to Remote output control .
	Control area	Specifies the areas for remote output control. To enable the function in some areas, the license needs to be imported and enabled.
	Output control duration	Specifies the time required for the inverter power output from 0% to 100% or from 100% to 0%.
	Remote output control server	Set this parameter to the IP address or domain name of the server.
	Enable certificate	Determine whether to import and enable the certificate as required.

NOTE

- If the connection between the SmartLogger and the server is abnormal, obtain the output control file in .data format from the website of the power company and import the file.
- After the SmartLogger connects to the server, you can export the relevant file.

----End

8.2 Reactive Power Adjustment

NOTE

- According to standard requirements, the SmartLogger can reliably adjust power for the connected inverters in real time to ensure that the PV plant can respond to requirements of the power grid company in a timely manner.
 - The reactive power control mode includes the following: No output, DI reactive scheduling, Reactive power fix control, Power factor fix control, Q-U characteristic curve, $\cos\phi$ -P/Pn characteristic curve, Q-U hysteresis curve(CEI0-16), Remote communication scheduling, Power factor closed-loop control (old policy), Power factor closed-loop control, PF-U characteristic curve, and Dry contact remote control(Q/S).
1. Log in as **Special User**, go to the **Reactive power control** page, set reactive power control parameters, and click **Submit**.

Figure 8-2 Reactive power control



IL02J00020

8.2.1 No Output

Parameter	Description
Reactive power control mode	If the PV plant is not required to adjust the voltage at the grid-tied point or perform reactive power compensation, inverters can run with only active power output. In this case, set this parameter to No output .

8.2.2 DI Reactive Scheduling

NOTICE

- When setting this function, ensure that the DI port for customized control is not occupied. Otherwise, the setting will fail.
- Before setting this function, ensure that the SmartLogger is properly connected to the Ripple Control Receiver.

Parameter	Description
Reactive power control mode	Set this parameter to DI reactive scheduling .

Parameter	Description
DI NOTE The DI parameters include DI5, DI6, DI7, DI8, and Power factor.	<ul style="list-style-type: none"> • Sixteen levels are supported for power factors. • "√/" indicates a low level. When connecting to GND2, the four DI ports of the SmartLogger are low-level ports. If not connected, the ports are high-level ports. • The percentage levels of DI5–DI8 should differ from each other. Otherwise, an abnormal command is generated. • If the actual input DI signal is inconsistent with that configured on the WebUI, the SmartLogger controls the inverter to work at full power and the Abnormal Reactive Schedule alarm is raised.

8.2.3 Reactive Power Fix Control

Parameter	Description
Reactive power control mode	If the PV array is required to generate constant reactive power at a specified time, set this parameter to Reactive power fix control .
Start time	If the inverter is required to run with specified maximum power in certain periods of a day, add setting records based on site requirements. When multiple time points are set, the inverter will run with the maximum power specified for the time point that is earlier than and the closest to the current system time. For example, if you add 00:00:00 and 12:00:00 on the WebUI and the current system current is 14:30:00, the inverter will run with the maximum power specified for 12:00:00.
Reactive power (kVar)	

8.2.4 Power Factor Fix Control

Parameter	Description
Reactive power control mode	If the PV plant is required to generate a constant power factor at the grid-tied point and the inverter is required to adjust the real-time reactive power based on the preset power factor, set this parameter to Power factor fix control .
Start time	If the inverter is required to run with a specified power factor in certain periods of a day, add setting records based on site requirements. When multiple time points are set, the inverter will run with the maximum power specified for the time point that is earlier than and the closest to the current system time. For example, if you add 00:00:00 and 12:00:00 on the WebUI and the current system current is 14:30:00, the inverter will run with the maximum power specified for 12:00:00.
Power factor	

8.2.5 Q-U Characteristic Curve

If you do not need the SmartLogger to send remote reactive power control commands, you can configure the characteristic curve on the SmartLogger as a substitute. The SmartLogger delivers the values configured for the characteristic curve to the inverter, which then operates in compliance with the configuration. The SmartLogger no longer adjusts the values.

NOTICE

Configure the characteristic curve under instructions from professionals to ensure that the SUN2000 works properly.

The Q-U characteristic curve control mode is to dynamically adjust the ratio Q/S of output reactive power to apparent power in accordance with the ratio U/Un(%) of the actual grid voltage to the rated grid voltage.

Parameter	Description
Reactive power control mode	Set this parameter to Q-U characteristic curve .
Reactive power adjustment time	Specifies the change interval of the reactive power for a grid-tied point.
Trigger power ratio	Under a specific grid code, after you set this parameter, the characteristic curve takes effect only when the actual output active power of the inverter is greater than the preset value.
Characteristic curve points	Specifies the number of characteristic curve points. The characteristic curve supports a maximum of 10 valid points.
U/Un(%)	When configuring the curve, ensure that the U/Un(%) value of a point is greater than the U/Un(%) value of the previous point. Otherwise, the message indicating invalid input will be displayed.
Q/S	

8.2.6 $\cos\phi$ -P/Pn Characteristic Curve

If you do not need the SmartLogger to send remote reactive power control commands, you can configure the characteristic curve on the SmartLogger as a substitute. The SmartLogger delivers the values configured for the characteristic curve to the inverter, which then operates in compliance with the configuration. The SmartLogger no longer adjusts the values.

NOTICE

Configure the characteristic curve under instructions from professionals to ensure that the SUN2000 works properly.

The $\cos\phi$ -P/Pn characteristic curve control mode is to dynamically adjust the power factor $\cos\phi$ in accordance with the P/Pn (%) based on the VDE-4105\BDEW German standard.

Parameter	Description
Reactive power control mode	Set this parameter to $\cos\phi$-P/Pn characteristic curve .
Characteristic curve points	Specifies the number of characteristic curve points. The characteristic curve supports a maximum of 10 valid points.
U/Un(%) $\cos\phi$	When configuring the curve, ensure that the P/Pn(%) value of a point is greater than the P/Pn(%) value of the previous point. Otherwise, the message indicating invalid input will be displayed.

8.2.7 Q-U Hysteresis Curve (CEI0-16)

If you do not need the SmartLogger to send remote reactive power control commands, you can configure the characteristic curve on the SmartLogger as a substitute. The SmartLogger delivers the values configured for the characteristic curve to the inverter, which then operates in compliance with the configuration. The SmartLogger no longer adjusts the values.

NOTICE

Configure the characteristic curve under instructions from professionals to ensure that the SUN2000 works properly.

The Q-U hysteresis curve (CEI0-16) control mode is the Italian standard CEI0-16 version of the Q-U characteristic curve. It dynamically adjusts the output reactive power of the inverter in accordance with the ratio of the actual voltage to the rated voltage. The final value should be in the form of Q/S.

Parameter	Description
Reactive power control mode	Set this parameter to Q-U hysteresis curve(CEI0-16) .
Reactive power adjustment time	Specifies the change interval of the reactive power for a grid-tied point.
Trigger power ratio	Under a specific grid code, after you set this parameter, the characteristic curve takes effect only when the actual output active power of the inverter is greater than the preset value.
U/Un(%) Q/S	When configuring the curve, ensure that the U/Un(%) value of a point is greater than the U/Un(%) value of the previous point. Otherwise, the message indicating invalid input will be displayed. When configuring the curve, ensure that the Q/S values at points A and B are the same and set in sequence, and that the

Parameter	Description
	Q/S values at points C and D are the same and set in sequence. Otherwise, a message indicating invalid input is displayed.

8.2.8 Remote Communication Scheduling

The NMS or independent power adjustment device sends scheduling commands over the communications port that works with Modbus-TCP or IEC104, without the need of user configuration or operation. The SmartLogger can automatically switch between scheduling modes and send scheduling commands.

Parameter	Description
Reactive power control mode	<p>Based on the Remote communication scheduling priority principle, the SmartLogger automatically changes Reactive power control mode to Remote communication scheduling after receiving a scheduling command from the upper NMS.</p> <p>When the parameter is set to Remote communication scheduling, the SmartLogger receives the scheduling commands from the upper NMS, resolves the commands for the inverters, and then sends the commands to all connected inverters.</p>

8.2.9 Power Factor Closed-loop Control (Old Policy)

NOTICE

Before setting the parameters, ensure that a power meter has been connected to the SmartLogger.

Parameter	Description
Reactive power control mode	Set this parameter to Power factor closed-loop control (old policy) .
Target power factor	Specifies the target power factor of the power meter.
Adjustment period	Specifies the interval for the SmartLogger to send adjustment commands.
Adjustment deadband	<p>Specifies the adjustment power factor precision.</p> <p>NOTE It takes effect only if the power factor for the power meter exceeds 0.9.</p>

8.2.10 Power Factor Closed-loop Control

To improve revenue, a PV plant needs to reduce or avoid power factor surcharge by performing reactive power compensation. To enable the function, set power factor closed-loop control parameters.

NOTICE

- You are advised to choose **Settings > Smart Reactive Power Compensation** and enable the smart reactive power compensation function.
- To enable the function, you need to select a scenario, set power meter, inverter, and control parameters. This section describes how to set power factor closed-loop control parameters.
- Before setting the parameters, ensure that a power meter has been connected to the SmartLogger.
- You need to purchase a valid license for the power factor closed-loop control and load the license before enabling it.

Parameter	Description
Reactive power control mode	Set this parameter to Power factor closed-loop control .
Electric meter power direction	When the inverter has no output power, set this parameter to Positive if the active power reading of the power meter is positive. Otherwise, set this parameter to Reverse . After the setting is complete, check the power direction of the power meter if you are not sure about it.
Power meter	Set this parameter to Smart meter .
Target power factor	Specifies the target power factor of the power meter. The target value should be larger than the appraisal value of the PV plant power factor.
Adjustment period	Specifies the interval for the SmartLogger to send adjustment commands.
Adjustment deadband	Specifies the adjustment power factor precision. NOTE It takes effect only if the power factor for the power meter exceeds 0.9.
Reactive compensation delay	Specifies the delay for starting the distributed power factor compensation when the current power factor is lower than the target power factor.

NOTE

When the SmartLogger receives a remote reactive power scheduling command from the PV plant, **Reactive power control mode** is automatically set to **Remote communication scheduling**. To perform reactive power compensation again, set **Reactive power control mode** to **Power factor closed-loop control** and set **Target power factor** correctly.

8.2.11 PF-U Characteristic Curve

If you do not need the SmartLogger to send remote reactive power control commands, you can configure the characteristic curve as a substitute. The SmartLogger delivers the values configured for the characteristic curve to the inverter, which then operates according to the configuration. The SmartLogger no longer adjusts the values.

NOTICE

Set the parameters of characteristic curves under instructions from professionals to ensure that the inverters work properly.

The control mode of the PF-U characteristic curve is to dynamically adjust the PF value in accordance with the ratio $U/U_n(\%)$ of the actual grid voltage to the rated grid voltage.

Parameter	Description
Reactive power control mode	Set this parameter to PF-U characteristic curve .
Characteristic curve points	Specifies characteristic curve points. The characteristic curve supports a maximum of 10 valid points.
$U/U_n(\%)$	When configuring the curve, ensure that the $U/U_n(\%)$ value of a point is greater than that of the previous point. Otherwise, the "Invalid input" message will be displayed.
PF	

8.2.12 Dry Contact Remote Control (Q/S)

NOTICE

When setting this function, ensure that the DI port for customized control is not occupied. Otherwise, the setting will fail.

Parameter	Description
Reactive power control mode	Set this parameter to Dry Contact Remote Control (Q/S) .
DI NOTE The DI parameters include DI5, DI6, DI7, DI8, and Q/S .	<ul style="list-style-type: none"> Supports 16 levels of power factors. "√" indicates low level. When connecting to GND2, the four DI ports of the SmartLogger are low-level ports. If not connected, the ports are high-level ports. The percentage levels of DI5–DI8 should differ from each other. Otherwise, an abnormal command is generated. If the actual input DI signal is inconsistent with that configured on the WebUI, the SmartLogger controls the

Parameter	Description
	inverter to work at full power and the Abnormal Reactive Schedule alarm is raised.

8.3 Remote Shutdown

Remote Shutdown over Dry Contacts

The SmartLogger can connect to SUN2000s over dry contacts and shut down the SUN2000s over OVGR signals.

The SmartLogger provides eight DI ports, that is, DI1(GND1) to DI4(GND1) and DI5(GND2) to DI8(GND2). An OVGR can connect to any DI port.

Figure 8-3 Networking

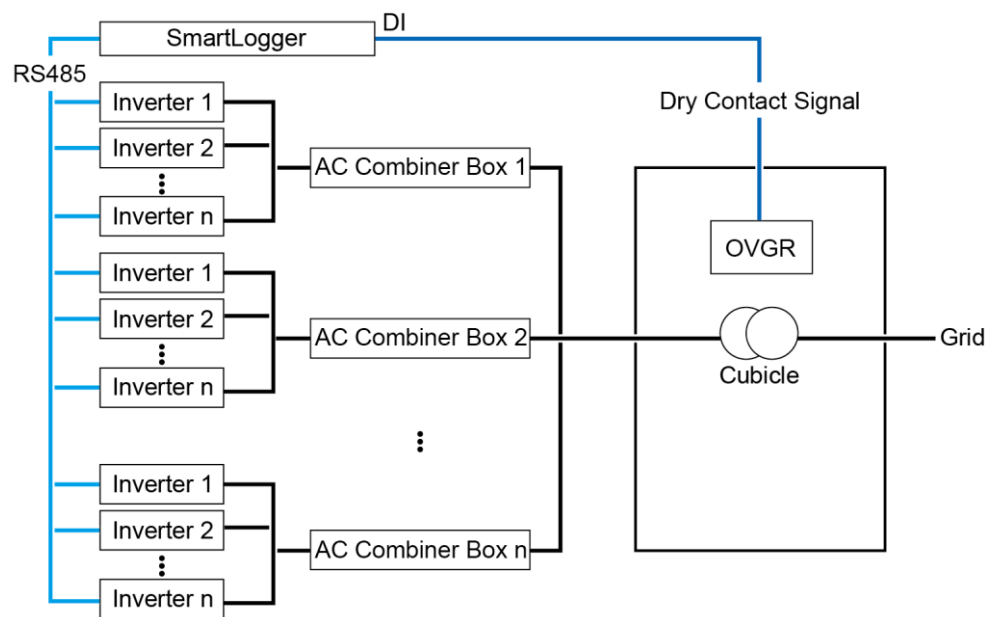

IL01IC3020

Figure 8-4 DI ports of the SmartLogger

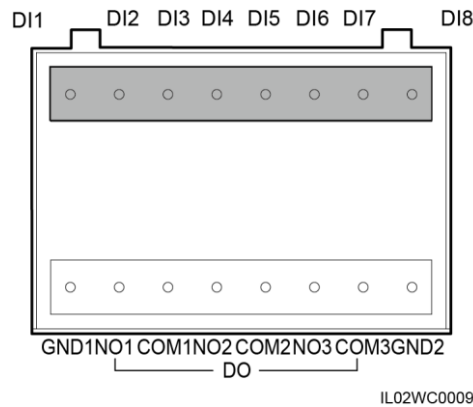

Table 8-1 DI port description

Port	Function
GND1	Dry contact input common terminal 1, used for active power derating for DI1–DI4
DI1	DI_1
DI2	DI_2
DI3	DI_3
DI4	DI_4
DI5	DI_5
DI6	DI_6
DI7	DI_7
DI8	DI_8
GND2	Dry contact input common terminal 2, used for reactive power compensation for DI5–DI8

NOTICE

Before setting the remote shut down over dry contacts using the following methods, ensure that the DI ports to be set have not been set in [8.4 Setting DI Parameters](#) or that the **Dry contact remote control** has not been set in [8 Power Grid Scheduling](#).

Because of permission restriction, log in as **Special User**. Choose **Settings > Remote Shutdown** to go to the target page.

Figure 8-5 Remote shutdown

Dry Contact Remote Shutdown	
connection port	No
Effective dry contact status	Open
OVGR shutdown	Disable
Cubicle alarm enabling	Disable

NOTE

- The OVGR sends dry contact signals and can be connected to any DI of the SmartLogger. Set related parameters based on the actual connection. Otherwise, the functions cannot be implemented.
- **Effective dry contact status** can be set to **Close** or **Open**. If **OVGR shutdown** is set to **Enable** and **Effective dry contact status** is set to **Close**, the SmartLogger sends the inverter remote shutdown command only when the DI port specified by **connection port** is **Close**.
- If **Cubicle alarm enabling** is set to **Enable**, the **Abnormal Cubicle** alarm is generated when the dry contact signal is effective and the Cubicle is abnormal.

Remote Shutdown over Wet Contacts

NOTICE

Before setting the remote shutdown over wet contacts using the following methods, ensure that the DI ports to be set have not been set in [8.4 Setting DI Parameters](#) or that the **Dry contact remote control** has not been set in [8 Power Grid Scheduling](#).

Because of permission restriction, log in as **Special User**. Choose **Settings > Remote Shutdown** to go to the target page.

Figure 8-6 Remote shutdown

Dry Contact Remote Shutdown	
connection port	No
Effective dry contact status	Open
OVGR shutdown	Disable
Cubicle alarm enabling	Disable

[Submit](#)

Table 8-2 Remote shutdown over wet contacts

Item	Description
Connection port	Set the parameter as the AI port for DRM signals.
Startup current range	If the current of the AI port is within the preset range, inverters are started. Otherwise, inverters are shut down.

8.4 Setting DI Parameters

You can set parameters for DI ports over the WebUI.

- When a valid level is delivered into a DI port, an alarm is generated. You can set the alarm name and severity.
- A DI port shuts down the inverter using OVGR signals.

The SmartLogger provides eight DI ports, that is, DI1(GND1) to DI4(GND1) and DI5(GND2) to DI8(GND2). For the connection method, see [4.10 Connecting a Ripple Control Receiver](#).

Because of permission restriction, log in as **Special User**. Choose **Settings > DI** to access the target page.

Figure 8-7 Setting DI parameters

DI Port Configuration							
DI	Activation Status	Dry Contact Status	Alarm Generation	Alarm Severity	Trigger Shutdown	Trigger Startup	Alarm Name
D11(GND1)	Disable	Open	Disable	Major	Disable	Disable	
D12(GND1)	Disable	Open	Disable	Major	Disable	Disable	
D13(GND1)	Disable	Open	Disable	Major	Disable	Disable	
D14(GND1)	Disable	Open	Disable	Major	Disable	Disable	
D11(GND2)	Disable	Open	Disable	Major	Disable	Disable	
D12(GND2)	Disable	Open	Disable	Major	Disable	Disable	
D13(GND2)	Disable	Open	Disable	Major	Disable	Disable	
D14(GND2)	Disable	Open	Disable	Major	Disable	Disable	

Startup Delay

Startup delay: [0-1800]s

NOTE

If a DI port is activated, it cannot be set again under **Dry contact remote control** in [8.3 Remote Shutdown](#) and [8 Power Grid Scheduling](#). If a DI port has been set in [8.3 Remote Shutdown](#) or has been set to **Dry contact remote control** in [8 Power Grid Scheduling](#), it cannot be set here again.

- **Activation Status:** If the DI port is set to **Activated**, you can set the function of this DI port. If the DI port is not set to **Activated**, you cannot set the function of this DI port.
- **Dry Contact Status** can be set to **Open** or **Close**. If **Activation Status** is set to **Activated** and **Dry Contact Status** is set to **Close**, it means that only when the DI port is set to **Close**, the SmartLogger sends the inverter remote shutdown command.
- If the SmartLogger connects to inverters over dry contacts and **Trigger Shutdown** is set to **Enable**, the SmartLogger shuts down the inverters over OVGR signals.

8.5 Setting Export Limitation Parameters

Network Application

When the PV plant generates power for private use only, the loads cannot consume all the power. If countercurrent feeds into the power grid, you can set the export limitation parameters over the WebUI.

- Scenario without a circuit breaker: The countercurrent feeding into the power grid can be eliminated by sending a command from the SmartLogger to lower the inverter output power.
- Scenario with a circuit breaker: When the countercurrent feeding into the power grid cannot be eliminated by sending a command from the SmartLogger to lower the inverter output power, and the **Maximum protection time** is exceeded, the SmartLogger drives the relay to switch off the circuit breaker by controlling the DO port. When the DI port detects that the circuit breaker is open, the DO port and relay on the SmartLogger will be switched off, and the SmartLogger will restore to the initial state.

Figure 8-8 Network diagram (without a circuit breaker)

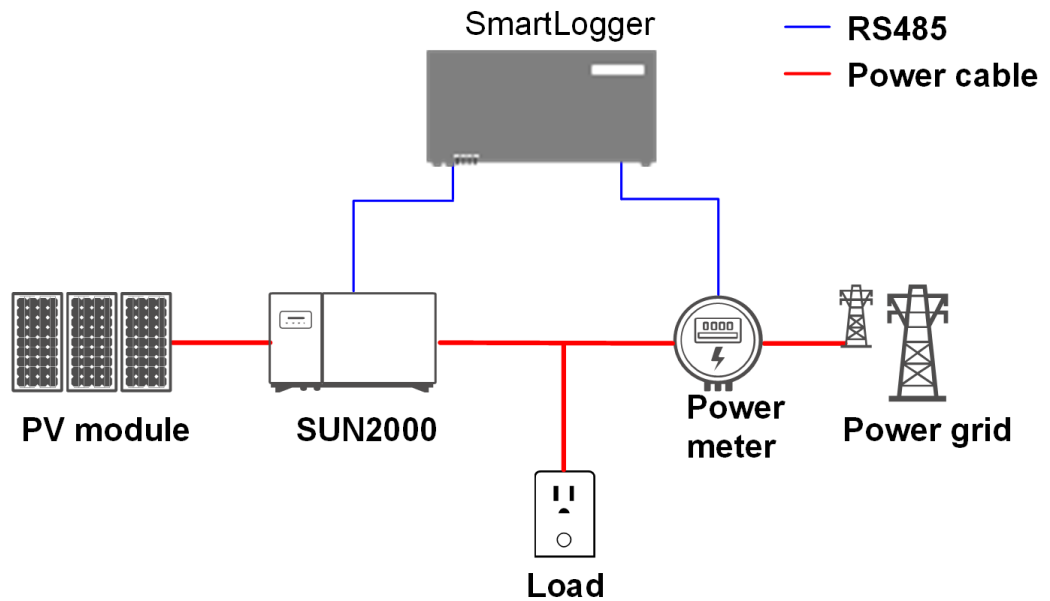
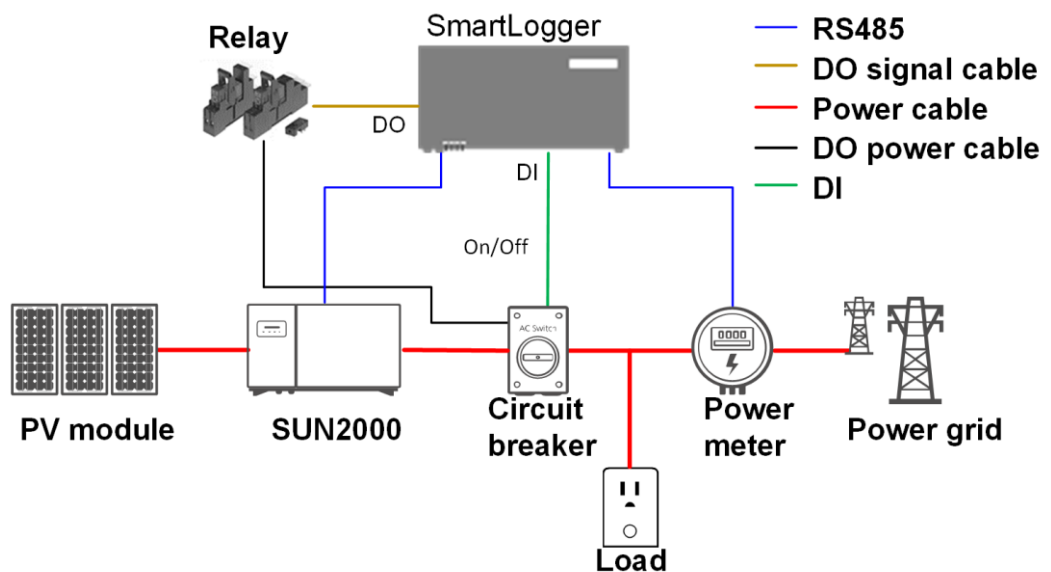

Figure 8-9 Network diagram (with a circuit breaker)



CAUTION

In the scenario with a circuit breaker, put the power supply position of the SmartLogger before the circuit breaker to avoid the SmartLogger power-off after the DO control circuit breaker is switched off.

Setting Parameters

NOTE

- Before setting export limitation parameters, ensure that the inverter has connected to the SmartLogger.
 - If the Modbus power meter has been connected to the SmartLogger, the meter access procedure in the wizard is only used as a check guide. If no Modbus power meter has been connected to the SmartLogger, add a power meter as instructed by the wizard.
 - You need to purchase a valid license for the export limitation and load the license before enabling it.
1. Log in as **Special User**, go to the **Export Limitation** page, set inverter parameters and export limitation parameters according to the wizard, and click **Submit**.

Figure 8-10 Setting export limitation parameters

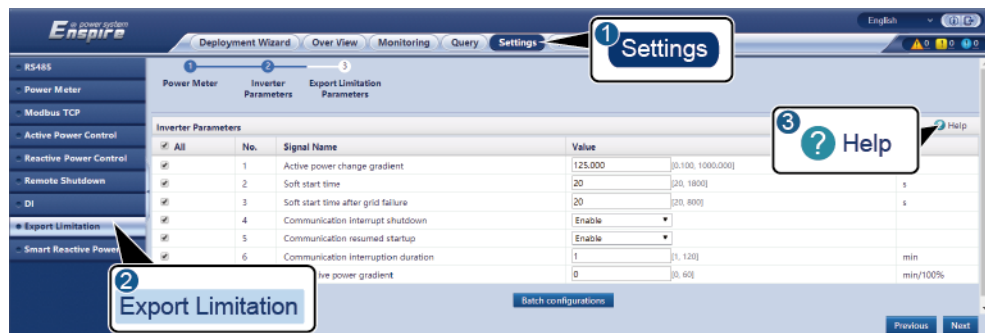

IL02J00014

8.6 Setting Smart Reactive Power Compensation Parameters

The smart reactive power compensation algorithm obtains the power data of the gateway power meter through the SmartLogger, performs intelligent algorithm analysis, adjusts the reactive power output of the inverter, optimizes the power factor of the gateway, and reduces or avoids power factor charge to increase the energy yield of the PV plant.

NOTE

- Before setting the parameters, ensure that the inverters are connected to the SmartLogger.
- If a power meter has been connected to the SmartLogger, the meter access procedure in the wizard is only used as a check guide. If no power meter has been connected to the SmartLogger, add a power meter as instructed by the wizard.
- You need to purchase a valid license for the smart reactive power compensation and load the license before enabling it.

1. Log in as **Special User**, go to the **Smart Reactive Power Compensation** page, and set the parameters as instructed by the wizard, and click **Submit**.

Figure 8-11 Smart reactive power compensation

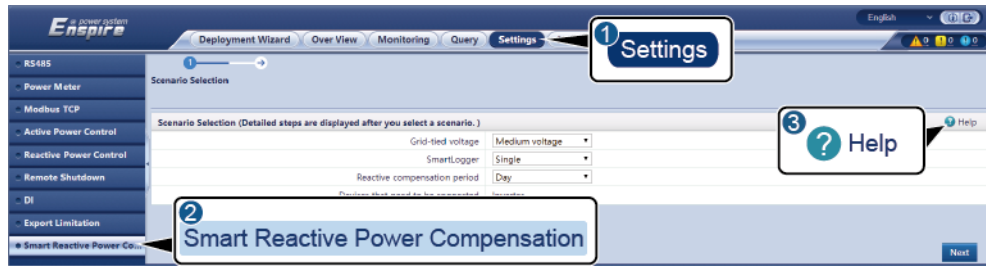

IL02J00013

----End

9 Device Maintenance

9.1 Routine Maintenance

- Ensure that the SmartLogger is free from strong electromagnetic interference.
- Ensure that the SmartLogger is away from heat sources.
- Ensure that the heat dissipation holes are not blocked.
- Regularly clean the SmartLogger.
- Regularly check that cables are secured.

9.2 Troubleshooting

Table 9-1 Common faults and troubleshooting methods

No.	Symptom	Possible Cause	Suggestion
1	The SmartLogger cannot be powered on.	<ol style="list-style-type: none">1. The DC output power cable for the power adapter does not connect to the 12V IN port of the SmartLogger.2. The power cable does not connect to the AC power receiving port of the power adapter.3. The AC input power cable does not connect to the AC socket.4. The power adapter is faulty.5. The SmartLogger is faulty.	<ol style="list-style-type: none">1. Connect the DC output plug of the power adapter to the 12V IN port of the SmartLogger.2. Check that the power cable connects to the AC power receiving port of the power adapter.3. Check that the power cable connects to the AC socket.4. Replace the power adapter.5. Contact the vendor or Huawei technical support.
2	No device is found.	<ol style="list-style-type: none">1. The COM port does not connect to any device, or the cable is loose, disconnected, or reversely connected.2. RS485 communications parameters are not correctly set, and the inverter address is beyond the search range preset on the SmartLogger.3. The devices that cannot be detected automatically, such as the EMI and	<ol style="list-style-type: none">1. Check the RS485 cables. If they are loose, disconnected, or connected reversely, reconnect them securely and correctly.2. Check that the settings of RS485 communications parameters, such as the baud rate and communications address, are correctly set, and that the inverter address is within the search

No.	Symptom	Possible Cause	Suggestion
		electricity meter, are not manually added.	<p>range preset on the SmartLogger.</p> <ol style="list-style-type: none"> 3. Manually add the devices that cannot be detected automatically, such as the EMI and electricity meter. 4. Contact the vendor or Huawei technical support.
3	The communication for MBUS (PLC) networking fails.	<ol style="list-style-type: none"> 1. The inverter is equipped with no MBUS (PLC) STA. 2. The AC power cable is loose, disconnected, or reversely connected. 3. The upstream circuit breaker for the AC power cable is switched off. 4. If the MBUS (PLC) module is networked, set Built-in MBUS or Networking to Disable. 5. The SmartLogger is faulty. 	<ol style="list-style-type: none"> 1. Verify that the inverter is equipped with a MBUS (PLC) STA. 2. Check the AC power cable. If it is loose, disconnected, or connected reversely, reconnect it securely and correctly. 3. Check that the upstream circuit breaker for the AC power cable is switched on. 4. Set Built-in MBUS and Networking to Enable. 5. Contact the vendor or Huawei technical support.
4	The communication for optical fiber networking fails.	<ol style="list-style-type: none"> 1. The optical fiber jumper is loose, disconnected, or reversely connected. 2. The optical module is loose, disconnected, or incorrectly inserted. 3. The Ethernet optical port is faulty. 	<ol style="list-style-type: none"> 1. Check the optical fiber jumper. If the optical fiber jumper is loose, disconnected, or connected reversely, reconnect it securely and correctly. 2. Check the connection of the optical module. If the module is not inserted properly, insert it again. 3. Check that the Ethernet optical port indicator blinks normally. Contact the vendor or Huawei technical support if the indicator is abnormal. 4. Contact the vendor or Huawei technical support.
5	The device status is displayed as disconnected on the SmartLogger.	<ol style="list-style-type: none"> 1. The cable between the device and the SmartLogger is loose or disconnected. 2. The device is powered off. 3. The baud rate or RS485 address of the device is changed. 4. The device is replaced. 5. The device is removed and not reconnected. 	<ol style="list-style-type: none"> 1. Check the cable between the device and the SmartLogger. If it is loose or disconnected, reconnect it securely. 2. Check the device connection and power on the device. 3. Check that the baud rate and RS485 address of the device are set correctly. 4. If any device is replaced, enable the SmartLogger to search for the device again or manually add the device. 5. If the device is removed from the SmartLogger, remove the device on the device management interface.
6	The EMI fails in communication	1. The RS485 communications cable between the EMI and the SmartLogger is connected incorrectly,	1. Check the RS485 communications cable. If it is loose or disconnected, reconnect it securely and correctly.

No.	Symptom	Possible Cause	Suggestion
	n.	<ul style="list-style-type: none"> 1. loose, or disconnected. 2. The EMI is not powered on. 3. The EMI and SmartLogger use different RS485 communications parameter settings. 4. The EMI parameters are not set correctly. 	<ul style="list-style-type: none"> 2. Power on the EMI. 3. Check that the RS485 communications parameters are correctly set on the EMI. 4. Log in to the WebUI and ensure that the EMI parameters are set correctly.
7	The SmartLogger cannot communicate with the NetEco deployed on the PC.	<ul style="list-style-type: none"> 1. The SmartLogger is not connected to the PC, or the cable is loose or disconnected. 2. Ethernet parameters are not set correctly. 3. NetEco parameters are not set correctly. 	<ul style="list-style-type: none"> 1. Check that the Ethernet electrical port or optical port of the SmartLogger correctly connects to a PC or router. 2. Check that Ethernet parameters are set correctly. 3. Check that NetEco parameters are set correctly.
8	The SmartLogger cannot communicate with the optical port of the Ethernet switch.	<ul style="list-style-type: none"> 1. The Ethernet switch is not powered on. 2. The optical module is not inserted into the SmartLogger or is inserted incorrectly. 3. The optical jumper is loose or disconnected. 4. The optical jumper is connected reversely. 	<ul style="list-style-type: none"> 1. Check that the remote Ethernet switch is powered on. If no, power it on. 2. Check whether the optical module is inserted based on the status of the indicator for the SmartLogger optical port. If the module is not inserted, insert it. 3. Check that the optical jumper is securely connected. If the jumper is loose or disconnected, reconnect it securely. 4. Check that the transmit end (TX) of the SmartLogger optical port connects to the receive end (RX) of the Ethernet switch optical port. If the optical jumper is reversely connected, reconnect it correctly.
9	The communication fails in RS485 networking.	<ul style="list-style-type: none"> 1. The RS485 communications cable connection is incorrect, loose, disconnected. 2. The SmartLogger or its connected device is not powered on. 3. The RS485 communications parameter values are incorrect. 	<ul style="list-style-type: none"> 1. RJ45 network port connection: Check that the RJ45 connector is properly crimped and that each core wire connects to the correct pin. 2. Terminal block connection: Check that the RS485 communications cable is connected to the correct port on the terminal block. 3. Verify that the RS485 ports of other devices connect to the correct ports on the SmartLogger. 4. Check the RS485 cables. If they are loose, disconnected, or connected reversely, reconnect them securely and correctly. 5. Power on the SmartLogger and its connected device.

No.	Symptom	Possible Cause	Suggestion
			6. Check the settings of RS485 communications parameters. 7. Contact the vendor or Huawei technical support.

9.3 Alarm List

Table 9-2 describes the common alarms for the SmartLogger and the troubleshooting measures.

Table 9-2 Alarm list

Alarm ID	Alarm Name	Alarm Severity	Alarm Sub-ID	Cause	Measures
1100	Abnormal Active Schedule	Major	4	Under the active power Dry contact remote control mode, the four DI ports read command combinations not configured.	1. Verify that the cables are connected correctly to the DI ports. 2. Access the active power Dry contact remote control configuration page and check the mapping table of the DI signal configuration. Contact the power grid company and verify that the combination configurations in the table are complete and meet the requirements of the company.
1101	Abnormal Reactive Schedule	Major	4	Under the reactive power Dry contact remote control mode, the four DI ports read command combinations not configured.	1. Verify that the cables are connected correctly to the DI ports. 2. Access the reactive power Dry contact remote control configuration page and check the mapping table of the DI signal configuration. Contact the power grid company and verify that the combination configurations in the table are complete and meet the requirements of the company.
1103	MCB Disconnect	Major	1	The general breaker at the grid connection point is disconnected.	Check whether the disconnection is normal. If it is abnormal, contact service engineers to restore the breaker.
1104	Abnormal Cubicle	Major	1	The Cubicle device has detected an exception at the grid connection point.	When the Cubicle alarm is enabled, check whether the DI signal received by the SmartLogger is consistent with the dry contact status. If so, restart the inverter.

Alarm ID	Alarm Name	Alarm Severity	Alarm Sub-ID	Cause	Measures
1105	Device Address Conflict	Major	1	The SmartLogger RS485 address conflicts with the physical address (RS485 address) or logical address for the connected southbound device.	<ul style="list-style-type: none"> If the SmartLogger RS485 address conflicts with the communication address for the connected southbound device, choose Settings > Modbus TCP and change the SmartLogger address, or choose Maintenance > Device Mgmt. > Connect Device and change the southbound device address. If the southbound device is a SUN2000, you can change its address on the app. If the SmartLogger RS485 address conflicts with the logical address for the connected southbound device, choose Settings > Modbus TCP and change the SmartLogger address.
1106	AC SPD fault	Major	1	The SPD in the smart array controller is faulty.	<ul style="list-style-type: none"> Check whether the cable to the SPD in the smart array controller is loose, disconnected, or connected in reverse. If so, reconnect the cable securely. Check whether the SPD in the smart array controller is faulty. Replace the faulty SPD.
1107-1 114	DI1 custom alarm-D I8 custom alarm	Major	1	The dry contact signal from the peripheral to the corresponding DI port on the SmartLogger is abnormal.	<ul style="list-style-type: none"> Check the DI port cable connection. If the cable is loose, disconnected, or connected in reserve, reconnect it securely. Verify that the relevant device works properly.
1115	24V power failure	Major	1	The 24 V power module in the smart array controller is faulty.	<ul style="list-style-type: none"> Check whether the cable to the 24 V power module in the smart array controller is loose, disconnected, or connected in reverse. If so, reconnect the cable securely. Check whether the 24 V power module in the smart array controller is faulty. Replace the faulty power module.
1119	License Expired	Warning	1	<ul style="list-style-type: none"> The privilege certificate has entered the grace period. The privilege feature will be invalid 	Apply for a new license for replacement.

Alarm ID	Alarm Name	Alarm Severity	Alarm Sub-ID	Cause	Measures
				soon.	

10 FAQ

10.1 How Do I Set Anti-crosstalk Parameters?

When MBUS is used for communication between the SmartLogger and the inverter, anti-crosstalk parameters must be set in the following scenarios:

- The SmartLogger detects inverters of another subarray.
- The SmartLogger detects more inverters than those belonging to the corresponding subarray, while an adjacent SmartLogger detects less inverters than those belonging to the corresponding subarray.
- The AC power cables for different transformer stations are routed along the same trench or cable trough.
- The voltage on the high-voltage side of the transformer station is 10 kV.
- There are multiple windings on the low-voltage side of the multi-split transformer station, such as the dual-split transformer station.
- Two or more SmartMBUSs are installed on the low-voltage side of the transformer station.

NOTE

After replacing or adding a device such as an inverter, a SmartLogger, or a SmartMBUS in a subarray, you need to reset the anti-crosstalk parameters of the device.

Setting Anti-crosstalk Parameters Through an SN List

- Step 1** Collect the SNs of the inverters in the subarray corresponding to the SmartLogger.
- Step 2** Log in to the SmartLogger as **Advanced User** and choose **Monitoring > MBUS > Networking Settings**.
- Step 3** On the **SN list** tab page, click **Template** and fill in the collected SNs based on the template.
- Step 4** Click **Import** to import the SN list to the SmartLogger.
- Step 5** On the **Running Param.** tab page, set SmartMBUS parameters **Box-type transformer No.** and **Winding No.** as required, set **Anti-crosstalk** to **Enable**, confirm the selected items, and click **Submit**.
- Step 6** Click **Synchronize** to synchronize the transformer station number and winding number to the inverter in the subarray.

----End

Setting anti-crosstalk parameters based on the transformer station number and winding number.

- Step 1** Log in to the SmartLogger as **Advanced User** and choose **Monitoring > MBUS > Networking Settings**.
- Step 2** On the **Running Param.** tab page, set SmartMBUS parameters **Box-type transformer No.** and **Winding No.** as required, set **Anti-crosstalk** to **Enable**, confirm the selected items, and click **Submit**.
- Step 3** Log in to the SUN2000 app as **Advanced User**, choose **Function Menu > Settings > Comm. Param. > MBUS**, and set transformer station number and winding number for all inverters in the subarray as required.

----End

FAQ

FAQ	Possible Causes	Suggestions
After anti-crosstalk parameters are set, the number of the detected inverters do not match that of the inverters in the subarray.	<ol style="list-style-type: none"> The inverters in other subarrays are detected. The SN list is incorrect. The three-phase input switch on the smart array controller is off. The switch between the SmartLogger or SmartMBUS and the busbar of the transformer station is off. The three-phase AC power cable is a single core cable. 	<ol style="list-style-type: none"> Do not set the anti-crosstalk parameters for the subarray until the operation is performed on other subarrays. Check whether the SN list and SNs of the inverters in the subarray are consistent. Turn on or replace the three-phase input switch on the smart array controller. Turn on or replace the switch between the SmartLogger or SmartMBUS and the busbar of the transformer station. In the US, set Network frequency band to 1.7–4.9 (MHz). In other regions, set this parameter to 0.5–3.7 (MHz), 2.5–5.7 (MHz), or 2–12 (MHz) as required.
Inverters cannot be networked through MBUS.	The SmartMBUS board is faulty.	Contact Huawei technical support.

10.2 Which Models of Power Meters and EMIs Are Supported by the SmartLogger?

Table 10-1 Supported power meters

Vendor	Model	Export Limitation
--------	-------	-------------------

Vendor	Model	Export Limitation
Janitza	UMG604/UMG103/UMG104	Supported
NARUN	PD510	N/A
Acrel	PZ96L	Supported
algotue	UPM209	Supported NOTE When the power meter connects to the SmartLogger, an external 120-ohm resistor needs to be connected to the RS485 bus of the power meter. For details, see the user manual of the power meter.
CHNT	DTSU666	N/A
CHNT	DTSU666-H	N/A
Socomec	COUNTIS E43	Supported NOTE <ul style="list-style-type: none"> • Not applicable to single-phase power scenarios. • When the power meter connects to the SmartLogger, an external 120-ohm resistor needs to be connected to the RS485 bus of the power meter. For details, see the user manual of the power meter.
ABB	A44	N/A
Netbiter	CEWE	N/A
Schneider	PM1200	N/A
SFERE	PD194Z	N/A
Lead	LD-C83	N/A
MingHua	CRDM-830	N/A
People	RM858E	N/A
elster	A1800ALPHA	N/A
Mitsubishi	LMS-0441E	N/A
Toshiba	S2MS	N/A

 **NOTE**

The SmartLogger can connect to only one power meter that uses the Modbus-RTU protocol.

Table 10-2 Supported EMIs

Vendor	Model	EMI Information
--------	-------	-----------------

Vendor	Model	EMI Information
JinZhou YangGuang	PC-4	Total irradiance, ambient temperature, PV module temperature, wind direction, and wind speed
HanDan	RYQ-3	Total irradiance, ambient temperature, PV module temperature, wind direction, and wind speed
ABB	VSN800-12	Total irradiance, ambient temperature, and PV module temperature
	VSN800-14	Total irradiance, ambient temperature, PV module temperature, wind direction, and wind speed
Kipp&Zonen	SMPx series	Total irradiance and ambient temperature
Lufft	WSx-UMB	Total irradiance, ambient temperature, wind direction, and wind speed
	WSx-UMB(external sensors)	Total irradiance, ambient temperature, PV module temperature, wind direction, and wind speed
Hukseflux SRx	Hukseflux SRx	Total irradiance and ambient temperature
MeteoControl	SR20-D2	Total irradiance and ambient temperature
RainWise	PVmet-150	Total irradiance, ambient temperature, and PV module temperature
	PVmet-200	Total irradiance, ambient temperature, PV module temperature, wind direction, and wind speed
Gill MetPak Pro	Gill MetPak Pro	Total irradiance, ambient temperature, PV module temperature, wind direction, and wind speed
Ingenieurbüro Si-RS485TC	Ingenieurbüro Si-RS485TC	Total irradiance, ambient temperature, PV module temperature, and wind speed
Meier-NT ADL-SR	Meier-NT ADL-SR	Total irradiance, ambient

Vendor	Model	EMI Information
		temperature, PV module temperature, and wind speed
Soluzione Solare	SunMeter	Total irradiance and ambient temperature
JinZhou LiCheng	JinZhou LiCheng	Total irradiance, ambient temperature, PV module temperature, wind direction, and wind speed
Sensor ADAM NOTE The sensor-type EMI (current-type or voltage-type) communicates with the SmartLogger through the ADAM analog-to-digital converter.	N/A	N/A

11 SmartLogger Disposal

If the service life of the SmartLogger expires, dispose of the SmartLogger according to the local disposal act for waste electric appliances.

12 Technical Specifications

Device Management

Item	SmartLogger2000-10/10-B/ 11-B	SmartLogger2000-10-C/11-C
Maximum number of managed devices	200	
Maximum number of managed inverters	80	150
Communication mode	Six RS485 ports, two Ethernet electrical ports, two Ethernet optical ports, and MBUS	
Maximum communication distance	RS485: 1000 m; Ethernet: 100 m; optical fiber: 12,000 m	

Display

Item	SmartLogger2000-10/10-B/ 11-B	SmartLogger2000-10-C/11-C
Bluetooth	SUN2000 app access	
LED	Four LED indicators	
WebUI	Embedded WebUI	

Bluetooth

Item		SmartLogger2000 -10/10-B/11-B	SmartLogger2000-10-C/11-C
Bluetooth EDR or Bluetooth LE	Operating Frequency	2402-2480 MHz	
	EIRP Power	0 dBm (+/-2dBm)	

Item	SmartLogger2000-10/10-B/11-B	SmartLogger2000-10-C/11-C
Bluetooth driver version	V200	

Common Parameters

Item	SmartLogger2000-10/10-B/11-B	SmartLogger2000-10-C/11-C
Power supply	100–240 V AC, 50 Hz/60 Hz	
Power consumption	Typical: 8 W; maximum: 15 W	
Dimensions (W x H x D)	Including mounting ears	411 mm x 170 mm x 58.6 mm
	Excluding mounting ears	350 mm x 170 mm x 43.6 mm
Net weight	2.5 kg	
Operating temperature	–40°C to +60°C	
Storage temperature	–40°C to +70°C	
Relative humidity (non-condensing)	5%–95%	
Protection level	IP20	
Installation mode	Installed on a wall or guide rail, or inside Huawei smart array controller	
Highest altitude	4000 m ^a	
a: When the altitude ranges from 3000 m to 4000 m, the temperature decreases by 1°C for each additional 200 m.		

Ports

Item	SmartLogger2000-10/10-B/11-B	SmartLogger2000-10-C/11-C
Ethernet electrical port	10/100 M	
Ethernet optical port	100 M ^a	
MBUS (PLC) port	1	
RS485	6; supported baud rates: 2400 bit/s, 4800 bit/s, 9600 bit/s, 19,200 bit/s, and 115,200 bit/s	

Item	SmartLogger2000-10/10-B/ 11-B	SmartLogger2000-10-C/11-C
USB	USB2.0	
Digital input	8, supporting only the access from relay dry contacts	
Digital output	3, relay dry contact output, normally open by default, supporting 12 V DC @ 500 mA power source	
Analog input	8 ^b	2, PT100/PT1000 port
		7 ^c
Analog output port	6, 4–20 mA and 0–20 mA current output	4, 4–20 mA and 0–20 mA current output
<p>a: Supports only the 100M optical module. To obtain the optical module and optical jumper (1310 nm, single-mode), you can purchase Huawei's optical ring fitting bag.</p> <p>b:</p> <ul style="list-style-type: none"> SmartLogger2000-10: AI1–AI4: 4–20 mA and 0–20 mA current input (passive); AI5–AI8: 4–20 mA and 0–20 mA current input (active) SmartLogger2000-10-B/11-B: AI1: 0–10 V voltage input (passive); AI2–AI4: 4–20 mA and 0–20 mA current input (passive); AI5–AI8: 4–20 mA and 0–20 mA current input (active) <p>c: The AI1 port on the SmartLogger2000-10-C/11-C supports 0–10 V voltage input (passive); The AI2–AI7 ports support 0–20 mA and 4–20 mA current input (passive).</p>		

13 Product User Lists

NOTE

Use the initial password upon first power-on and change it immediately after login. To ensure account security, change the password periodically and keep the new password in mind. Not changing the initial password may cause password disclosure. A password left unchanged for a long period of time may be stolen or cracked. If a password is lost, devices cannot be accessed. In these cases, the user is liable for any loss caused to the PV plant.

Table 13-1 Monitoring user lists

Login Mode	User Name	Initial Password
App	Common User	00000a
	Advanced User	00000a
	Special User	00000a
Web	Common User	Changeme
	Advanced User	Changeme
	Special User	Changeme
NetEco	emscmm	/EzFp+2%r6@IxSCv

Table 13-2 Operating system user lists

User Name	Initial Password
enspire	Changeme
root	Changeme
prorunacc	No initial password
bin	No initial password
daemon	No initial password
nobody	No initial password

User Name	Initial Password
sshd	No initial password

14 Domain Name List of Management Systems

 **NOTE**

The list is subject to change.

Table 14-1 Domain names of management systems

Domain Name	Data Type	Scenario
intl.fusionsolar.huawei.com	Public IP address	FusionSolar hosting cloud NOTE The domain name is compatible with cn.fusionsolar.huawei.com (Chinese mainland).
neteco.alsoenergy.com	Public IP address	Partner management system
re-ene.kyuden.co.jp	Public IP address	Remote output control server of Kyushu Electric Power Company
re-ene.yonden.co.jp	Public IP address	Remote output control server of Shikoku Electric Power Company

15 Acronyms and Abbreviations

A

AC	alternating current
AI	analog input
AO	analog output
APP	application
ATB	Access Terminal Box

C

CCO	central coordinator
COM	communication

D

DI	digital input
DO	digital output

E

EDR	enhanced data rate
EIRP	equivalent isotropically radiated power
EMI	environmental monitoring instrument
ETH	Ethernet

L

LE	low power
LED	light-emitting diode
M	
MBUS	monitoring bus
P	
PLC	power line communication
R	
RSTP	Rapid Spanning Tree Protocol
S	
SFP	small form-factor pluggable
STA	station
STP	Spanning Tree Protocol
W	
WEEE	waste electrical and electronic equipment

A Installing and Wiring the RS485 Signal SPD

A.1 Installing the RS485 signal SPD

- If the SmartLogger2000-10/10-B/11-B needs to connect to an outdoor device over a COM port, you are advised to connect an RS485 signal SPD between the SmartLogger and the device to strengthen the surge protection capability.
- Each RS485 signal SPD can connect to two COM ports. Each SmartLogger can be configured with a maximum of three RS485 signal SPDs.
- For a smart array controller factory-installed with the SmartLogger2000-10/10-B/11-B, the RS485 signal SPD has been installed before delivery. In a non-smart array controller, the RS485 signal SPD can be mounted on a guide rail.

NOTE

When determining the installation position, verify that the linear distance between the RS485 signal SPD and the SmartLogger is not greater than 500 mm.

Prerequisites

- Prepare an RS485 signal SPD. The recommended model is PowerSA-5KA-15V and can be purchased from Huawei.
- To install an RS485 signal SPD on a guide rail, prepare a 35 mm wide standard guide rail that complies with the specifications shown in [Figure A-1](#). The recommended valid guide rail length is 80 mm or greater.

Figure A-1 Guide rail dimensions (unit: mm)

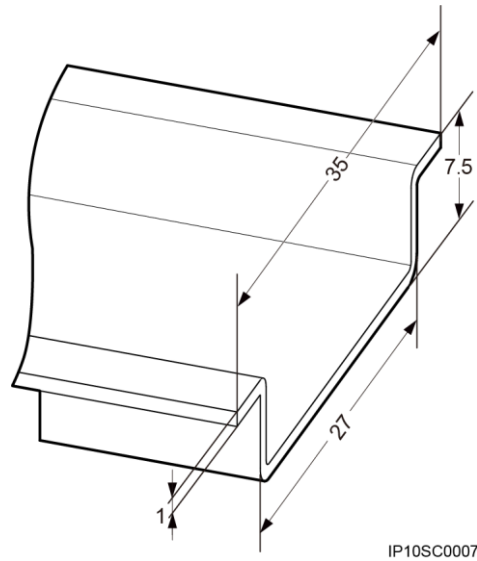

NOTICE

- If the SmartLogger is to be installed on a guide rail, the RS485 signal SPD can share the guide rail with the SmartLogger. In this case, the recommended guide rail length is 600 mm or greater.
- Secure the guide rail before mounting the RS485 signal SPD.

Procedure

Step 1 Secure the RS485 signal SPD to the guide rail.

Figure A-2 Securing an RS485 signal SPD

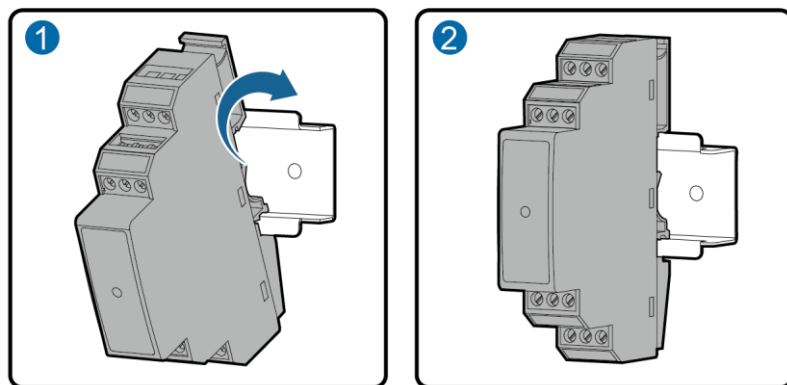

----End

A.2 Connecting the RS485 Signal SPD

When connecting the RS485 signal SPD, you need to connect its PE cable and communications cable.

Prerequisites

- Prepare a ground cable. Recommended: outdoor copper-core cable with a cross-sectional area of 4 mm² or 12 AWG
- Prepare a communications cable, for example, a two-core or multi-core cable with a cross-sectional area of 0.5–2.5 mm².

Context

NOTE

The way of connecting two to three RS485 signal SPDs is the same as the way of connecting one RS485 signal SPD.

One RS485 signal SPD provides two RS485 surge protection ports.

Figure A-3 Ports on an RS485 signal SPD

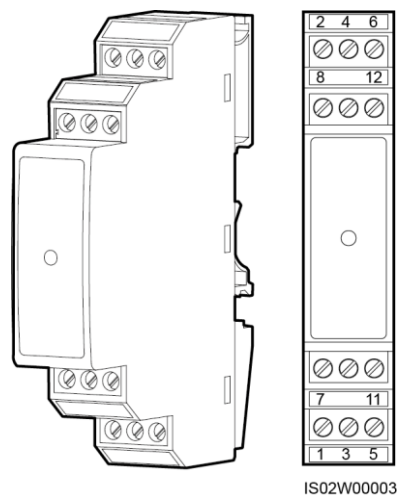

Table A-1 Port description

RS485 Surge Protection Port	Protection Port	Function	Surge Port	Function
RS485 surge protection port 1	2	RS485A, RS485 differential signal+	1	RS485A, RS485 differential signal+
	6	RS485B, RS485 differential signal–	5	RS485B, RS485 differential signal–
RS485 surge protection port 2	8	RS485A, RS485 differential signal+	7	RS485A, RS485 differential signal+
	12	RS485B, RS485	11	RS485B, RS485 differential

RS485 Surge Protection Port	Protection Port	Function	Surge Port	Function
		differential signal-		signal-

NOTE

- Protection ports connect to the COM ports on the SmartLogger. Port 4 is not connected.
- Surge ports connect to the RS485 ports on other devices. Port 3 is the ground port.
- Protection ports and surge ports must not be confused.
- One RS485 signal SPD can protect two COM ports.
- Protection ports 2 and 6 and surge ports 1 and 5 form an RS485 surge protection port for protecting one COM port. Protection ports 8 and 12 and surge ports 7 and 11 form another RS485 surge protection port for protecting another COM port.
- An RS485 signal SPD port supports cables with a maximum cross-sectional area of 2.5 mm². If devices need to be connected to this port in parallel, use cables with a cross-sectional area of 1 mm², and connect not more than two cables to the same port.

Procedure

Connect the PE cable.

1. Remove 8 mm of the insulation layer from the PE cable using a wire stripper.
2. Insert the bare core wire into port 3 on the RS485 signal SPD, and secure the cable.

Figure A-4 Connecting a PE cable

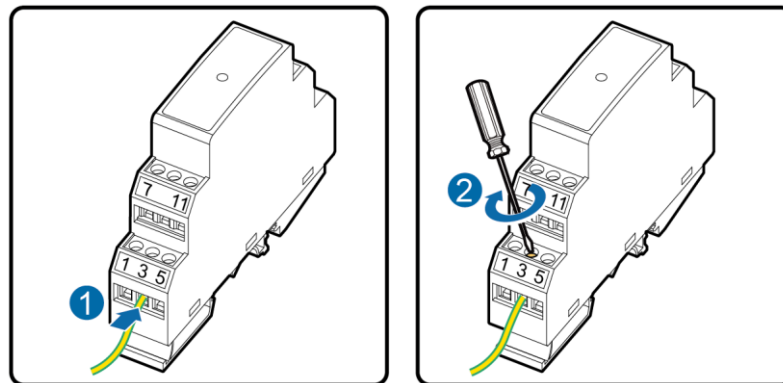

IL02IC1001

NOTE

- Connect the other end of the PE cable to the ground bar.
- Recommended: To enhance the corrosion resistance of a ground terminal, silica gel or paint might be needed.

----End

Connect the communications cable.

1. Connect one end of the cable to the COM port on the SmartLogger. For details, see [4.3 Connecting Cables to the Terminal Block on the COM Port](#).

2. Insert the bare core wire at the other end into a protection port on the RS485 signal SPD, and secure the cable.

Figure A-5 Connecting communications cables (1)

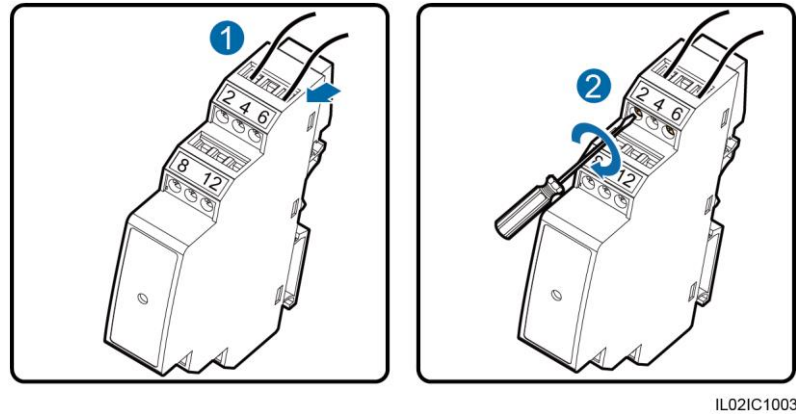

NOTICE

Verify that the COM+ (RS485A) port on the SmartLogger connects to protection port 2 or 8 on the RS485 signal SPD, and that the COM- (RS485B) port on the SmartLogger connects to protection port 6 or 12 on the RS485 signal SPD.

3. Strip cables.

Figure A-6 Stripping a cable (unit: mm)

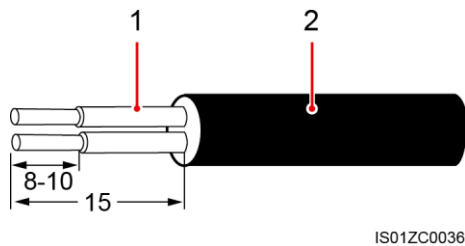

(1) Insulation layer

(2) Armored layer

4. Insert the bare core wire into the surge port on the RS485 signal SPD, and secure the cable.

Figure A-7 Connecting communications cables (2)

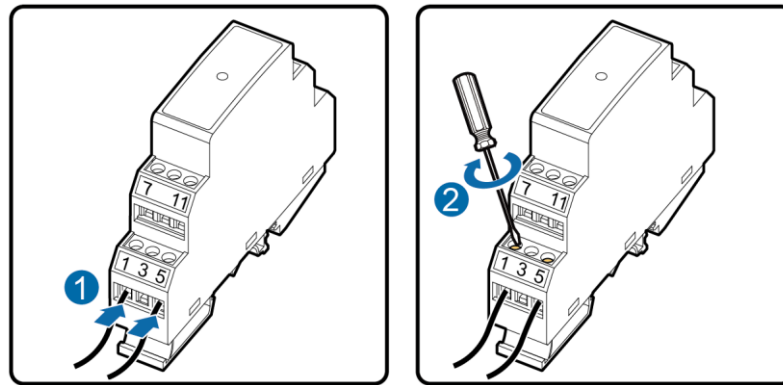

IL021C1002

5. Connect the other end of the cable to the communications port on the connected device.

NOTICE

Verify that the RS485A port on the device connects to surge port 1 or 7 on the RS485 signal SPD, and that the RS485B port on the device connects to surge port 5 or 11 on the RS485 signal SPD. For details about cable connections, see the description about the connected device.

----End